



2026





**TOUT LES MODÈLES PRÉSENTÉS SONT DES MOTOS AUX NORMES CE. VÉHICULE NON HOMOLOGUÉ ET INTERDIT SUR LA VOIE PUBLIQUE. USAGE RÉSERVÉ UNIQUEMENT SUR CIRCUIT FERMÉ ET PRIVÉ. TOUJOURS PORTER UN CASQUE, DES LUNETTES ET DES VÊTEMENTS DE PROTECTIONS. NE JAMAIS MONTER EN TANT QUE PASSAGER.**

**YCF SE RÉSERVE LE DROIT DE MODIFIER LES CARACTÉRISTIQUES ET LES PRIX DE SES PRODUITS. TOUTE REPRODUCTION MÊME PARTIELLE DE CE CATALOGUE DOIT FAIRE L'OBJET D'UN ACCORD PRÉALABLE AVEC YCF.**

ALL MODELS PRESENTED MEET EC STANDARDS. VEHICLES ARE NOT AUTHORIZED ON PUBLIC ROADWAYS. RESERVED FOR USE ON CLOSED AND PRIVATE TRACKS ONLY. ALWAYS WEAR HELMET, GOGGLE AND ADAPTED PROTECTIONS. NEVER RIDE WITH A PASSENGER.

YCF RESERVES THE RIGHT TO MODIFY THE SPECIFICATIONS OR THE PRICES OF ITS PRODUCTS. ANY REPRODUCTION IN WHOLE OR IN PART OF THIS CATALOGUE REQUIRES THE PRIOR AGREEMENT OF YCF.



**YANNICK COQUARD  
CO-FOUNDER & FORMER  
PROFESSIONAL RACER**

**NORMANDIE, FRANCE**

**DEPUIS 2004, YCF® DÉVELOPPE ET FABRIQUE DES MOTOS POUR LE GRAND PUBLIC, LE LOISIR ET LA COMPÉTITION. CHAQUE ANNÉE UNE NOUVELLE GAMME COMPLÈTE DE MOTOS FIABLES, ACCESSIBLES ET PERFORMANTES EST PROPOSÉE AFIN DE PROFITER PLEINEMENT DES JOIES DE LA MINI MOTO EN TOUTE SÉCURITÉ. 100% DES PRODUITS YCF SONT CONÇUS, DÉVELOPPÉS ET DESSINÉS EN INTERNE. GRACE AU DÉVELOPPEMENT EN COMPÉTITION, LES PRODUITS YCF BÉNÉFICIENT DES DERNIÈRES ÉVOLUTIONS DISPONIBLES POUR LE GRAND PUBLIC, POUR TOUTE LA FAMILLE.**

**BON RIDE À TOUS**

NORMANDY, FRANCE

YCF® HAS BEEN DEVELOPING AND MANUFACTURING MOTORCYCLES FOR THE PAST 16 YEARS. OUR BIKES ARE MATCHED TO SKILL LEVELS FROM BEGINNERS TO ADVANCED. WHETHER YOU'RE PLAY RIDING OR COMPETING, THERE'S A BIKE FOR YOU! EACH YEAR A NEW RANGE OF RELIABLE, AFFORDABLE AND HIGH-PERFORMANCE MOTORCYCLES ARE INTRODUCED. ALLOWING YOU TO EXPERIENCE ALL THE FUN MINI BIKES HAVE TO OFFER. 100% OF YCF PRODUCTS ARE DEVISED, DESIGNED AND DEVELOPED IN-HOUSE. DUE TO BEING DEVELOPED UNDER COMPETITION CONDITIONS, YCF® TAKE'S ADVANTAGE OF THE VERY LATEST ADVANCES. THANK YOU FOR CHOOSING YCF®.

ENJOY YOUR RIDE!



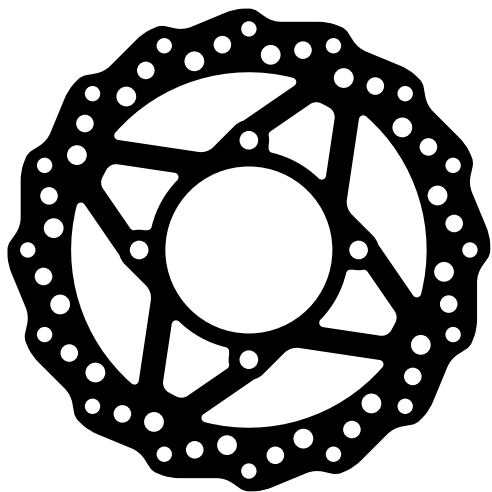

FACTORY PARTS



FOR 50 ONLY



FOR SUPERMOTO



FOR BIGY® ONLY



FOR GP ONLY



ARRO® TIRES



DAYTONA® ENGINES



ENGI® FORK



MIKUNI® CARBURETORS



KEIHIN® CARBURETORS



SPECIAL PARTS



NIBBI CARBURETORS®



KENDA® TIRES



DNM® SUSPENSIONS



TWINAIR® FILTERS





## GAMME 2026 RANGE 2026

MINI YCF 12	10
MINI YCF 16	12
PIÈCES DRAISIENNES/ BALANCE BIKES PARTS	14
50AE	16
W50	18
LITE 88S	22
LITE 125	24
LITE 150	26
LITE 150L	28
START 88SE	30
W88	32
START 125SE	34
PILOT 150	36
FACTORY 150 SP2	38
FACTORY 190 SP3 DAYTONA®	40
BIGY 150	42
BIGY 150 FACTORY	44
BIGY 190 FACTORY DAYTONA® XL	46
SM 125	48
SM 155	50
SM 190 DAYTONA®	52
GP 124	54
GP 157	56
GP 187 DAYTONA®	58
PIÈCES GP/ GP PARTS	60
PADDOCK/ PADDOCK	66
TEXTILES/ APPAREL	68

## ACCESSOIRES PLASTIQUES PLASTIC PARTS

KITS DÉCO/ GRAPHIC KITS	70
KITS PLASTIQUES/ PLASTIC KITS	76

## PIÈCES MOTO CYCLE PARTS

GUIDONS/ HANDLEBARS	84
POIGNÉES/ LEVERS	86
FOURCHES/ FORKS	88
CADRES/ FRAMES	91
SELLES/ SEATS	92
RÉSERVOIRS/ FUEL TANKS	93
FREINS/ BRAKES	94
BRAS OSCILLANTS/ SWING ARMS	102
AMORTISSEURS/ SHOCK ABSORBERS	104
ROUES/ WHEELS	105
JANTES & MOYEUX/ RIMS & HUBS	105
PNEUS/ TIRES	112
REPOSE-PIEDS & SABOTS/ FOOT PEGS & SKID PLATES	114
SÉLECTEURS/ SHIFT LEVERS	115
KITS CHAÎNES/ SPROCKET KITS	116
OUTILS/ TOOLS	118
ENGI®/ ENGI®	120

## PIÈCES MOTEUR ENGINE PARTS

MOTEURS DAYTONA®/ DAYTONA® ENGINES	124
MOTEURS/ ENGINES	124
KITS MOTEUR/ ENGINE KITS	126
EMBRAYAGE/ CLUTCH	129
CARBURATEURS/ CARBURETORS	131
FILTRES À AIR/ AIR FILTERS	133
ÉCHAPPEMENTS/ EXHAUSTS	134
FILTRES & RADIATEURS/ FILTERS & COOLERS	137
ALLUMAGE/ IGNITION	138
HUILE YCF/ YCF LUB	140
PIÈCES RACING DAYTONA®/ DAYTONA® RACING PARTS	142
PIÈCES D'ORIGINE DAYTONA®/ DAYTONA® GENUINE PARTS	143

# INDEX - FRANÇAIS FRENCH / 2026

## A

AIGUILLE DE CARBURATEUR.....	131
ALLUMAGE.....	138/142
AMORTISSEUR.....	104/121
ANTIPARASITE.....	139
ARBRE DE BOÎTE.....	130
ARRACHE VOLANT.....	118
ATTACHE RAPIDE DE CHAÎNE.....	116
ATTACHE SILENCIEUX.....	134/135
AXE DE BRAS OSCILLANT.....	103
AXE DE ROUE.....	109
AXE DE PLAQUETTE DE FREIN.....	94

## B

BÂCHE MOTO.....	66
BAGUE DE FOURCHE.....	88/120
BANDEROLE.....	66
BANNER.....	66
BARRE DE REPOSE-PIED.....	114
BATTERIE.....	138
BAVETTE D'AMORTISSEUR.....	104
BÉQUILLE.....	67/91
BOB.....	68
BOBINE D'ALLUMAGE.....	138
BOÎTE À AIR.....	133
BONNET.....	68
BOUCHON DE CARTER D'ALLUMAGE.....	126
BOUCHON DE RÉSERVOIR.....	93
BOUCHON DE VALVE.....	112
BOUCHON DE VIDANGE.....	137
BOUCLE ARRIÈRE.....	91
BOUGIE.....	139
BRAS OSCILLANT.....	102
BRIDE DE POT.....	134

## C

CÂBLE DE GAZ ET D'EMBRAYAGE.....	87
CÂBLE DE PÉDALE DE FREIN.....	98
CACHE CULASSE.....	142
CACHE FILTRE À HUILE.....	142
CACHE POUSSIÈRE.....	120
CADRE.....	91
CAGE DE FILTRE À AIR.....	132
CALE PLASTIQUE DE PIPE D'ADMISSION.....	132

CALE DE PONTET DE GUIDON 20 mm.....	89
CAOUTCHOUC D'EMBRAYAGE.....	87
CAOUTCHOUC DE LEVIER DE FREIN.....	87
CAOUTCHOUC D'ÉTRIER.....	97
CAPOT DE MAÎTRE-CYLINDRE FREIN.....	101
CARBURATEUR.....	131
CARTER D'ALLUMAGE.....	126/127
CARTER D'EMBRAYAGE.....	129
CASQUETTE.....	69
CDI.....	138
CERCEAU DE ROUE.....	108/109
CHAÎNE.....	116
CHAÎNE DE DÉMARREUR.....	142
CHAÎNE DE DISTRIBUTION.....	126/142
CHAISE PLIABLE.....	66
CHAMBRE À AIR.....	112
CHAPE DE MAÎTRE-CYLINDRE.....	98
CHAPEAU.....	68
CHARGEUR BATTERIE.....	138
CLÉ À BOUGIE.....	118
CLÉ À RAYON.....	118
CLOCHE D'EMBRAYAGE.....	130
COCOTTE D'EMBRAYAGE.....	87
COLLECTEUR.....	136
COMPTEUR D'HEURES.....	139
CONTACTEUR À CLÉ.....	138
COUPE CIRCUIT.....	139
COURONNE.....	116/117
COURONNE D'EMBRAYAGE.....	129
COUVERTURE CHAUFFANTE (PAIRE).....	64/113
COUVRES RAYONS.....	109
COUVRE RÉSERVOIR.....	93
CULASSE.....	128
CYLINDRE.....	128

## D

DAYTONA® (PIÈCES).....	142-147
DB KILLER.....	134
DÉRIVE CHAÎNE.....	118
DÉMONTE PNEU.....	118
DÉMONTE NOIX EMBRAYAGE.....	118
DÉCO DE CADRE.....	70
DIABOLO CNC.....	102
DISQUE DE FREIN.....	100
DISQUE D'EMBRAYAGE.....	129
DONUTS.....	87
DURITE D'ESSENCE.....	93
DURITE DE FREIN.....	96/97
DURITE D'HUILE RADIATEUR.....	137

## E

ÉCHAPPEMENT.....	135-136
ÉCHAPPEMENT COMPLET.....	135
ÉCROU DE BÉQUILLE.....	91
ÉCROU DE COLONNE DE DIRECTION.....	90
EMBOUT DE PÉDALE DE FREIN.....	98
EMBOUT DE POT.....	134
EMBOUT DE MAÎTRE-CYLINDRE FREIN.....	98
EMBRAYAGE COMPLET.....	129
ENGI® (PIÈCES).....	120/121
ENTRETOISE D'AMORTISSEUR.....	104
ENTRETOISE DE ROUE.....	110
ÉPURATEUR D'HUILE.....	137
ÉTRIER DE FREIN.....	94/96/97

## F

FAISCEAUX ÉLECTRIQUES.....	138
FEUTRINE.....	66
FILTRE À AIR.....	133
FILTRE À HUILE.....	137
FOND DE JANTE.....	112
FOURCHE.....	88/120
FOURCHETTE DE BOÎTE.....	128
FREIN ARRIÈRE.....	94/95/97
FREIN AVANT.....	94/95/96
FREIN FILET.....	118

## G

GARDE BOUE ARRIÈRE.....	78/79
GARDE BOUE AVANT.....	76/79/81
GICLEUR.....	131
GRIPSTER.....	109
GUIDE DE CHAÎNE.....	103
GUIDON.....	85

## H

HUBLOT À HUILE.....	137
HUILE YCF.....	140/141

## J

JANTES.....	108-109
JAUGE À HUILE.....	137
JEU DE CALES MOTEUR.....	118
JEU DE RAYONS.....	109
JOINT DE BOUCHON DE RÉSERVOIR.....	93
JOINT DE CARTER D'EMBRAYAGE.....	130
JOINT DE COLONNE DE DIRECTION.....	90
JOINT DE CUVE POUR CARBURATEUR.....	131
JOINT PAPIER DE PIPE D'ADMISSION.....	132

JOINT DE POT .....	134
JOINT DE QUEUE DE SOUPAPE.....	128
JOINT SPY DE FOURCHE .....	88/120
JOINT SPY DE TIGE COMMANDE D'EMBRAYAGE .....	130
JOINT SPY DE KICK .....	130
JOINT SPY DE PSB .....	130
JOINT SPY DE ROUE.....	109
JOINT SPY DE SÉLECTEUR .....	130

## K

KICK .....	115
KIT 212cc .....	142
KIT ARBRE À CAMES RACING .....	130/142
KIT DÉCO .....	70-74
KIT DÉCO DE CADRE .....	70
KIT DÉPART .....	120
KIT FREIN .....	94/95/96/97
KIT LAMPE .....	82
KIT PISTON .....	127
KIT PLASTIQUE .....	76-81
KIT RABASSE.....	104
KIT RÉFECTION D'AMORTISSEUR .....	121
KIT RÉFECTION ENTRETOISE AXE AMORTISSEUR ...	121
KIT RÉFECTION DE FOURCHE.....	88
KIT RONDELLE CNC .....	82
KIT ROUE SUPERMOTARD .....	105
KIT ROULEMENT DE COLONNE DE DIRECTION .....	90
KIT STABILISATEUR .....	20
KIT SUPERMOTARD .....	114
KIT VIS.....	82/100/117/131

## L

LAINÉ DE ROCHE.....	134
LEVIER D'EMBRAYAGE .....	86/87
LEVIER DE FREIN .....	86/87/94

## M

MAÎTRE-CYLINDRE .....	94/96/97
MANCHON DE BOÎTE À AIR .....	132
MANCHON DE PIPE D'ADMISSION .....	132
MOTEUR .....	124-125
MOUSSE DE GUIDON .....	84
MOYEU .....	110

## O

ORIFLAMME .....	66
OUÏE DE RADIATEUR .....	76/79
OUTILLAGE.....	118/120

## P

PARAPLUIE .....	68
PASSE DURITE DE FREIN AVANT.....	82
PATTE DE CADRE .....	91
PATTE DE FREIN CNC.....	94
PATIN DE BRAS OSCILLANT .....	103
PATIN DE CHAÎNE .....	103
PÉDALE DE FREIN .....	98
PIÈCES D'ORIGINE DAYTONA®.....	142-147
PIÈCES DRAISIENNES .....	14-15
PIÈCES GP .....	60-64
PIGNON .....	128/130
PIGNON DE CLOCHE D'EMBRAYAGE .....	130
PIGNON DE SORTIE DE BOÎTE .....	116
PIPE D'ADMISSION .....	132/142
PISTON .....	127/142
PLANCHE DE STICKERS.....	73
PLAQUE AVANT.....	76/80
PLAQUES LATÉRALES.....	77/80
PLAQUE PHARE.....	82
PLAQUETTES DE FREIN .....	100
PLATEAU D'ALLUMAGE.....	138
PNEU.....	112-113
POCHETTE DE JOINTS .....	128
POIGNÉE DE GAZ .....	86
POIGNÉES CAOUTCHOUC.....	87
POIGNÉES DE PLAQUES LATÉRALE.....	77/80
POINTEAU DE CARBURATEUR.....	131
POLO .....	68
PONTET DE GUIDON .....	89
PROTECTION DE FOURCHE.....	78
PROTECTION DE PIGNON SORTIE BOÎTE.....	117
PROTECTION SM .....	114
PROTÈGE DISQUE ARRIÈRE .....	103
PROTÈGE DISQUE AVANT .....	82
PROTÈGE LEVIER .....	84
PROTÈGE MAIN .....	84
PROTÈGE MAÎTRE-CYLINDRE.....	98

## R

RAYONS.....	109
RADIATEUR D'HUILE .....	137
RÉGULATEUR DE TENSION .....	138
RELAIS DE DÉMARREUR .....	138
REPOSE PIED.....	114
RÉSERVOIR.....	93
RÉSERVOIR RÉCUPÉRATEUR HUILE/ ESSENCE .....	114
RESSORT D'AMORTISSEUR .....	104
RESSORT DE BÉQUILLE .....	91

RESSORT DE KICK.....	115
RESSORT DE PÉDALE DE FREIN.....	98
RESSORT DE POT .....	134/135
RESSORT POUR ÉTRIER RADIAL.....	94
ROBINET D'ESSENCE .....	93
ROUES.....	20/105-108
ROULEMENT DE COLONNE DE DIRECTION.....	90
ROULEMENT DE ROUE.....	109
ROULEMENT DE BRAS OSCILLANT .....	103
ROULETTE DE CHAÎNE.....	103
RUBALISE DE TERRAIN .....	66

## S

SABOT.....	114/115
SAC À DOS/TRANSPORT .....	68
SEGMENT .....	127
SÉLECTEUR .....	115
SELLE.....	92
SILENCIEUX .....	135
SOUPAPE.....	128
STARTER AU GUIDON .....	132
SUPPORT DE COMPTEUR D'HEURES .....	139
SUPPORT DE DÉMAREUR ÉLECTRIQUE .....	138
SURFILTRE À AIR .....	132
SWEAT .....	69

## T

TAPIS .....	67
TÉ DE FOURCHE .....	88/89
TEESHIRT.....	68/69
TENDEUR DE CHAÎNE .....	117
TIGE DE COMMANDE D'EMBRAYAGE .....	130
TONNELLE .....	66
TRÉPIED.....	67

## V

VALVE COUDÉE 90° .....	105
VALVE PRISE AIR .....	93
VILEBREQUIN.....	127
VIS DE BÉQUILLE .....	91
VIS DE COURONNE .....	117
VIS DE CUVE.....	131
VIS DE DISQUE .....	100
VIS DE RALENTI.....	131
VIS ET ÉCROU TENDEUR DE CHAÎNE .....	103
VIS DE PLAQUETTE DE FREIN .....	100
VIS DE RÉGLAGE DE LA POIGNÉE DE GAZ .....	86
VIS RENFORCÉES POUR MOTEUR .....	91
VIS DE RICHESSE .....	131
VISSERIE .....	82/91/117

# INDEX - ANGLAIS ENGLISH 2026

## A

AIR FILTERS.....	133
AIR FILTER CAGE .....	132
AIR FILTER PROTECTION.....	132
AIRBOX CAPS.....	133
AIRBOX RUBBER SLEEVES.....	132
AIRBOXES.....	133
APPAREL.....	68-69
AXLES.....	109

## B

BACKPACK.....	68
BANNER ROLL.....	66
BANNERS.....	66
BALANCE BIKES PARTS.....	14-15
BAR END CAPS.....	87
BAR MOUNTS.....	89
BATTERY CHARGER.....	138
BEANIE.....	68
BEARINGS.....	103/109
BIKE STANDS.....	67
BOLT KIT FOR AXLE BLOCK.....	103
BOLT KIT FOR BRAKE DISC.....	100
BOLT KITS FOR FUEL TANK.....	82
BOLT KIT FOR PLASTIC KIT.....	82
BOLT KIT FOR SEAT.....	82
BOLT KIT FOR SPROCKET.....	117
BRAKE CALIPERS.....	94/97
BRAKE CLEVIS.....	98
BRAKE DISCS.....	100
BRAKE GUARDS (FRONT).....	82
BRAKE HOSES.....	96/97
BRAKE LEVERS.....	86/87/94
BRAKE LEVER RUBBERS.....	87
BRAKE MASTER CYLINDERS.....	94/96/97
BRAKE PADS.....	100
BRAKE PEDALS.....	98
BRAKE RESERVOIR COVER.....	101
BRAKE SYSTEMS (COMPLETE).....	94-97
BUCKET HAT.....	68

## C

CAMSHAFT KIT.....	130/142
CAP BIG VIEW HOLE.....	126

CAPS.....	69
CARBURETOR FLOAT.....	131
CARBURETORS.....	131
CARBURETOR BOOT.....	132
CATCH CAN.....	114
CDI.....	138
CHAIN GUIDES.....	103
CHAIN LINKS.....	116
CHAIN SLIDERS.....	103
CHAIN TENSIONERS.....	103
CHAIN TOOLS.....	118
CHAINS.....	116
CHOKE LEVER.....	132
CLUTCH ASSEMBLY.....	129
CLUTCH BRACKET.....	87
CLUTCH CABLES.....	87
CLUTCH CONTROL OIL SEAL.....	130
CLUTCH COVER.....	129
CLUTCH FOR KICKSTARTER.....	129
CLUTCH LEVER RUBBERS.....	87
CLUTCH LEVERS.....	86/87
CLUTCH SPROCKET.....	128/129
CLUTCH TOOLS.....	118
COUNTERSHAFT SPROCKET.....	116
COUNTERSHAFT SPROCKET GUARD.....	117
CRANKSHAFTS.....	127
CYLINDERS.....	128

## D

DAYTONA ENGINE 212 KIT.....	142
DAYTONA® PARTS.....	142-147
DB KILLER.....	134
DISCS.....	100
DISC GUARD.....	82/103
DUST SEALS.....	109

## E

ELECTRIQUE STARTER STAND.....	138
ENGI®.....	120-121
ENGINE ADJUSTMENT GAUGES.....	118
ENGINE BASH PLATE STEEL.....	115
ENGINE KITS.....	128/142
ENGINE REINFORCED BOLT SETS.....	91
ENGINES (COMPLETE).....	124-125
EXHAUSTS.....	135-136
EXHAUST END.....	134
EXHAUST PIPE.....	135/136
EXHAUST SPRING.....	134/135
EXHAUST VALVE.....	128

## F

FENDER.....	76/79/81
FILTER.....	133
FLAGS (PROMOTIONAL).....	66
FLYWHEEL REMOVER.....	118
FOAM AIR FILTER.....	133
FOLDABLE LEVERS.....	86
FOLDING CHAIR.....	66
FOOT PEG MOUNT BAR.....	114
FOOT PEGS.....	114
FORK AIR BLEEDER.....	88
FORK BUSHINGS ENGI®.....	120
FORK GUARDS.....	78
FORK OIL SEALS.....	88/120
FORK SEAL REPAIR KIT.....	88/120
FORKS.....	88/120
FORK TOOL.....	120
FRAMES.....	91
FUEL CAPS.....	93
FUEL HOSES.....	93
FUEL TANKS.....	93
FUEL PETCOCK.....	93
FUEL VENT CAP.....	93

## G

GASKET SETS.....	128/130/131
GEARBOX FORK (REINFORCED).....	128
GEARBOX SHAFT.....	128
GEARBOX SHAFT (COMPLETE MAIN).....	128
GEARBOX SHAFT (COMPLETE SECONDARY).....	128
GP PARTS.....	60-64
GRAPHIC KITS.....	70-74
GRAPHICS FOR FRAME.....	70
GRIPS.....	87
GRIP DONUTS.....	87

## H

HANDGUARDS.....	84
HANDLEBAR PADS.....	84
HANDLEBARS.....	85
HATS.....	68/69
HEAD LIGHTS.....	82
HEIGHT ADJUSTMENT KIT.....	104
HIGH TENSION IGNITION COIL.....	138
HOLESHOT DEVICE.....	120
HOODIE.....	69
HOURLY METER.....	139
HUB SPACERS.....	110
HUBS.....	110

<b>I</b>	
IDLE SCREW + SPRING .....	131
IGNITION COVER .....	126
IGNITION SWITCH.....	138
INLET PIPE .....	132
INLET VALVE.....	128
INTAKE GASKET.....	132
INTAKE MANIFOLD .....	132

<b>K</b>	
KICKSTAND (ADJUSTABLE).....	91
KICKSTAND SPRING .....	91
KICKSTARTER LEVER OIL SEAL .....	130
KICKSTARTER LEVERS .....	115
KICKSTARTER SPROCKET .....	130
KILL SWITCH.....	138

<b>L</b>	
LIGHT.....	82
LEVER PROTECTION .....	84
LAUNCH CONTROL.....	118
LUBE YCF.....	140-141

<b>M</b>	
MAGNETIC DRAIN PLUG .....	137
MAGNETO .....	138
MAIN JET .....	131
MOTORCYCLE COVER.....	66
MUD FLAP .....	104
MUDGUARDS.....	76/78/79/81
MUFFLER .....	134/135
MUFFLER CLAMPS .....	134/135
MUFFLER SPARK ARRESTOR.....	134

<b>N</b>	
NEEDLE VALVE + SPRING .....	131
NUMBER PLATES.....	76/80
NUT FOR STEERING STEM.....	90

<b>O</b>	
OIL COOLER .....	137
OIL DIPSTICK .....	137
OIL DRAIN PLUG .....	137
OIL FILTER .....	137
OIL LEVEL SIGHT GLASS.....	137
OIL SEAL .....	109
OIL SEAL ASSEMBLY TOOLS.....	118
OIL SEAL FOR COUNTERSHAFT SPROCKET .....	130
OIL STEEL LINE RETAINER .....	82

OVAL MUFFLER CLAMP .....	134
--------------------------	-----

<b>P</b>	
PISTON KITS .....	127/142
PISTON RING SETS.....	127
PIT TENT (3X3M).....	66
PLASTIC KITS.....	70-81
POLO .....	68
PUSH ROD.....	130

<b>R</b>	
REAR BRAKE LEVER TIPS.....	98
REAR SPOOL.....	102
REGULATOR.....	138
REMOTE SWITCH.....	139
RIM LOCKS.....	109
RIMS.....	108-109
RUBBER MANIFOLD SET .....	132
RUBBER MAT.....	67

<b>S</b>	
SEAL FOR FUEL TANK CAP.....	93
SEAL FOR STEERING STEM.....	90
SEATS .....	92
SHAFT .....	128
SHIFT LEVERS.....	115
SHOCK ABSORBERS .....	104/121
SHOCK ABSORBERS REPAIR KIT.....	121
SHOCK ABSORBERS SPACER KIT .....	121
SHOCK ABSORBERS SPRING .....	104
SIDE PLATES.....	77/80
SKID PLATE .....	115
SLOW JET.....	131
SPACERS .....	104/110
SPACERS FOR BAR MOUNT .....	89
SPARK ARRESTOR.....	135
SPARK PLUG REMOVAL TOOL .....	118
SPARK PLUGS .....	139
SPOKE SKINS.....	109
SPOKE TOOL.....	118
SPOKE WRENCH .....	118
SPOKES .....	109
SPROCKETS.....	116/117
SPROCKET GUARD .....	117
SPROCKET LOCKING TAB .....	117
STABILIZED WHEEL KIT .....	20
STAND SCREW & NUT .....	91
STANDARD LEVERS .....	87
STARTER CHAIN .....	126
STARTER RELAY .....	138

STICKER SHEET (YCF).....	73
SUBFRAMES .....	91
SUPERMOTARD CATCH TANK KIT .....	114
SUPERMOTARD TEFLON PROTECTION SET .....	114
SUPPORTING PLATE FOR HOUR METER .....	139
SWING ARMS.....	102
SWING ARM SLIDER .....	103
SWITCH REMOTE CUT OFF (50CC).....	139

<b>T</b>	
TAIL LIGHT.....	82
TANK BOLT.....	131
TANK COVER .....	93
TANK SHROUDS.....	76/79
TAPER ROLLER BEARINGS.....	90
THREADLOCK.....	118
THROTTLE ADJUSTING SCREW.....	86
THROTTLE ASSEMBLY.....	87
THROTTLE CABLES .....	87
THROTTLE HANDLE.....	86
TIMING SPROCKET.....	126/142
TIRES.....	112/113
TIRE LEVER .....	118
TIRE VALVE CAPS .....	112
TIRE VALVE INNER .....	105
TIRE WARMERS.....	64/113
TOOLS .....	118/120
TRACK TAPE .....	66
TRAINING WHEEL KIT .....	20
TRANSPORT BAG.....	68
TRIPLE CLAMPS.....	88/89
T-SHIRTS .....	68/69
TUBES .....	20/112

<b>U</b>	
UMBRELLA .....	68

<b>V</b>	
VALVE ADJUSTMENT TOOL.....	118
VALVE CAP.....	112
VALVE STEM SEAL.....	128

<b>W</b>	
WASHER FOR STEERING STEM NUT.....	90
WHEEL ASSEMBLY (COMPLETE) .....	20/105-108
WIRING HARNESS .....	138

<b>Y</b>	
YCF PLASTIC HANDLES ON SIDE PLATES.....	77/80



YCF MINI 12

400-470mm/ 16-18,5 in.

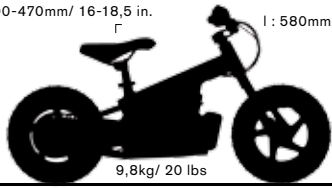

9,8kg/ 20 lbs

P.11

l : 580mm/ w: 23 in.

681mm/ w: 26,8 in.

981mm/ w: 38,6 in.



YCF MINI 16

470-540mm/ 18,5-21 in.

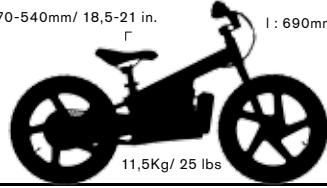

11,5Kg/ 25 lbs

P.13

l : 690mm/ w: 27 in.

771mm/ w: 30,3 in.

1177mm/ w: 46,3 in.



50AE  
W50

STANDARD 550mm/ 21 in.  
LOW 530mm/ 20 in.

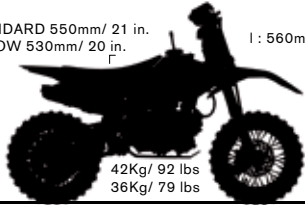

42Kg/ 92 lbs  
36Kg/ 79 lbs

P.17  
P.19

l : 560mm/ w: 22 in.

870mm/ w: 34 in.

1280mm/ w: 50 in.



W88

STANDARD 705mm/ 28 in.  
LOW 690mm/ 27 in.

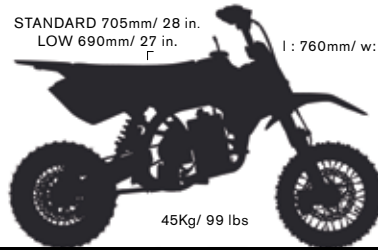

45Kg/ 99 lbs

P.33

l : 760mm/ w: 30 in.

1040mm/ 41 in.

1460mm/ 57 in.



START 88SE

STANDARD 705mm/ 28 in.  
LOW 690mm/ 27 in.

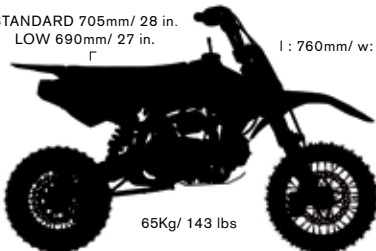

65Kg/ 143 lbs

P.31

l : 760mm/ w: 30 in.

1045mm/ 41 in.

1460mm/ 57 in.

STANDARD 745mm/ 29 in.  
LOW 720mm/ 28 in.

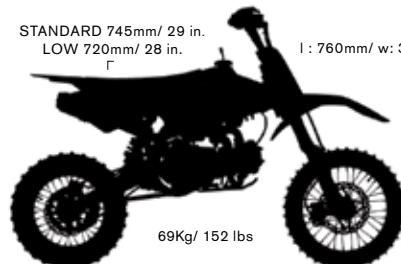

69Kg/ 152 lbs

P.35

l : 760mm/ w: 30 in.

1120mm/ 44 in.

1595mm/ 62 in.



CHOOSE  
YOUR  
WEAPON



LITE 88S

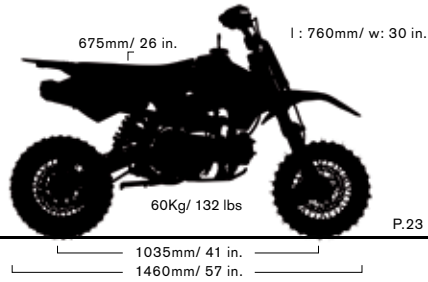

LITE 125

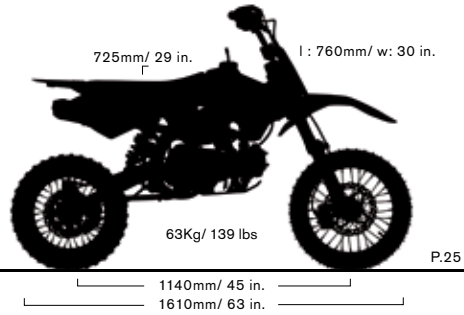

LITE150

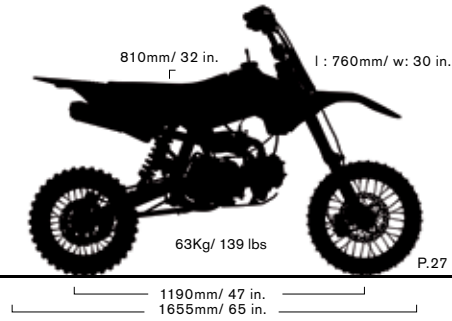

LITE 150L

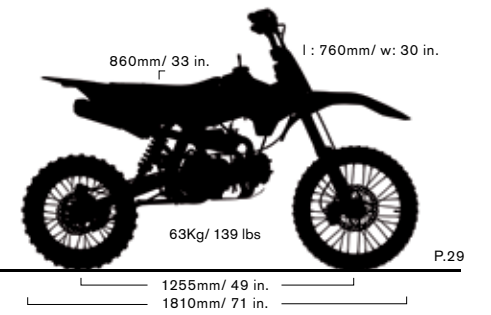

PILOT 150

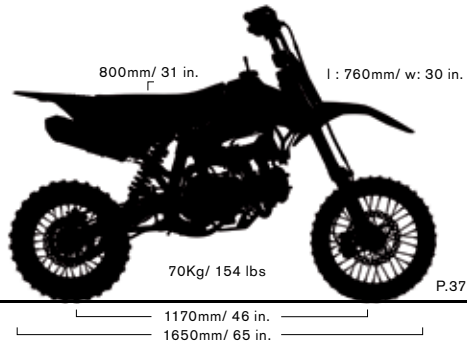

FACTORY 150 SP2

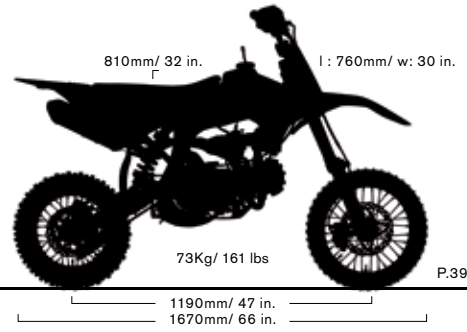

FACTORY 190 SP3 DAYTONA®

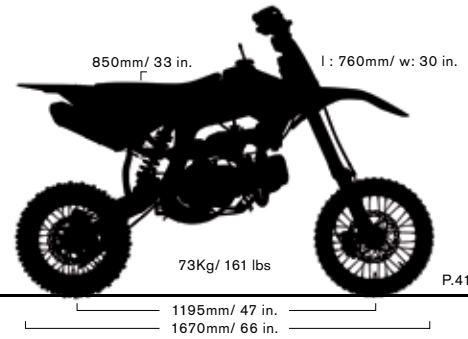

GP 124  
GP 157  
GP 187 DAYTONA®

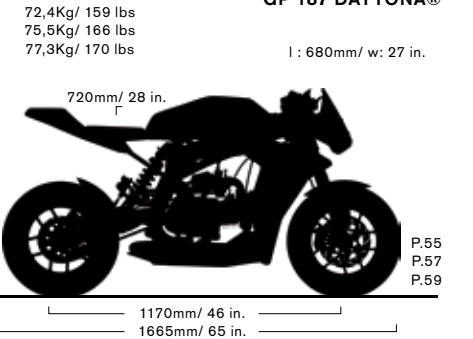

BIGY 150  
BIGY 150 FACTORY

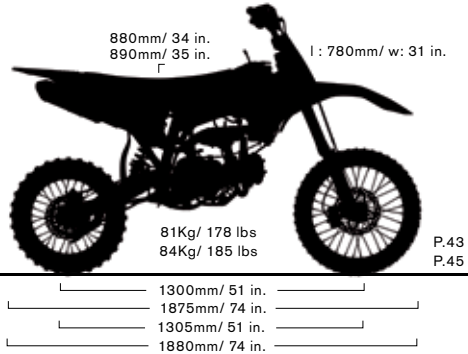

BIGY 190 FACTORY DAYTONA® XL

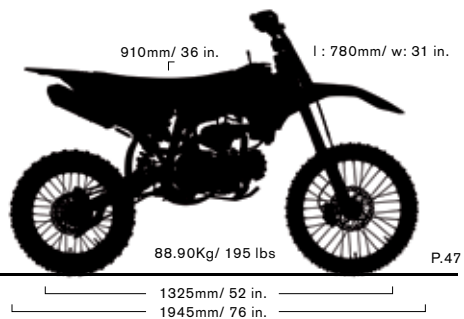

SM 125

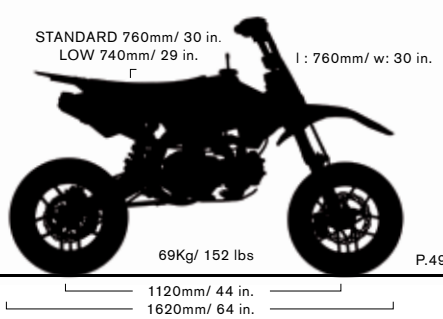

SM 150  
SM 190 DAYTONA®

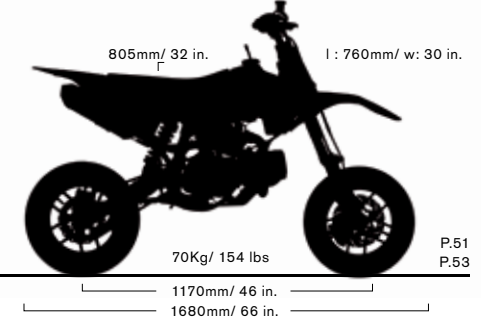



€ 399

**SPÉCIFICATIONS**

**MOTEUR DE 170W**  
**BATTERIE LITHIUM 24V**  
**TEMPS DE CHARGE DE 2,5-3 HEURES**  
**AUTONOMIE MOYENNE DE LA BATTERIE DE 60 MINUTES,**  
**VARIABLE SELON L'UTILISATION**

**SPECIFICATIONS**

**ENGINE 170W**  
**BATTERY LITHIUM 24V**  
**CHARGE TIME 2,5-3 HOURS**  
**AN AVERAGE BATTERY LIFE OF 60 MINUTES**  
**VARYING WITH USAGE**

**2026 YCF MINI 12**  
**POCKET-ROCKET**

**POINTS FORTS & NOUVEAUTÉS 2026**

**TROIS VITESSES POSSIBLE**  
**SYSTÈME DE ROUE LIBRE ARRIÈRE**  
**RETRAIT FACILE DE LA BATTERIE**  
**POUR LES ENFANTS DE 3 À 5 ANS**  
**CADRE EN ALUMINIUM**  
**TAILLE DES ROUES 12'**  
**NOUVELLE PLAQUE AVANT**  
**POIGNÉES YCF**  
**COULEUR DISPONIBLE: BLEU/ VERT/ ORANGE/**  
**ROSE/ ROUGE/ JAUNE/ GRIS**

**HIGHLIGHTS & 2026 NEW FEATURES**

**3 SPEED POSITIONS**  
**FREEWHEEL**  
**EASY BATTERY REMOVAL**  
**FOR CHILDREN FROM 3 TO 5 YEARS OLD**  
**ALUMINUM FRAME**  
**WHEEL SIZE 12'**  
**NEW FRONT PLATE**  
**YCF GRIPS**  
**COLOR AVAILABLE: BLUE/ GREEN/ ORANGE/ PINK/ RED/**  
**YELLOW/ GREY**

# Mini YCF 12



400-470mm / 16-18,5 in.

 9,8Kg / 20 lbs

l: 580mm / w: 23 in.

681mm / 26,8 in.

981mm / 38,6 in.



€ 499

**SPÉCIFICATIONS**

**MOTEUR DE 250W**  
**BATTERIE LITHIUM 24V**  
**TEMPS DE CHARGE DE 5-6 HEURES**  
**AUTONOMIE MOYENNE DE LA BATTERIE DE 60 MINUTES,**  
**VARIABLE SELON L'UTILISATION**

**SPECIFICATIONS**

**ENGINE 250W**  
**BATTERY LITHIUM 24V**  
**CHARGE TIME 5-6 HOURS**  
**AN AVERAGE BATTERY LIFE OF 60 MINUTES,**  
**VARYING WITH USAGE**

**2026 YCF MINI 16  
 POCKET-ROCKET**

**POINTS FORTS & NOUVEAUTÉS 2026**

**TROIS VITESSES POSSIBLE**  
**SYSTÈME DE ROUE LIBRE ARRIÈRE**  
**RETRAIT FACILE DE LA BATTERIE**  
**POUR LES ENFANTS DE 5 À 7 ANS**  
**CADRE EN ALUMINIUM**  
**TAILLE DES ROUES 16"**  
**NOUVELLE PLAQUE AVANT**  
**NOUVEAU CONTROLEUR 18A**  
**NOUVEAU KIT CHAÎNE 9T/65**  
**POIGNÉES YCF**  
**COULEUR DISPONIBLE: BLEU/ VERT/ ORANGE/**  
**ROSE/ ROUGE/ JAUNE/ GRIS**

**HIGHLIGHTS & 2026 NEW FEATURES**

**3 SPEED POSITIONS**  
**FREEWHEEL**  
**EASY BATTERY REMOVAL**  
**FOR CHILDREN FROM 5 TO 7 YEARS OLD**  
**ALUMINUM FRAME**  
**WHEEL SIZE 16"**  
**NEW FRONT PLATE**  
**NEW 18A CONTROLLER**  
**NEW 9T/65 CHAIN KIT**  
**YCF GRIPS**  
**COLOR AVAILABLE: BLUE/ GREEN/ ORANGE/ PINK/ RED/**  
**YELLOW/ GREY**

# Mini YCF 16



470-540mm/ 18,5-21 in.

 11,5Kg/ 25 lbs

L : 690mm/ W: 27 in.

771mm/ 30,3 in.

1177mm/ 46,3 in.

# PIÈCES DRAISIENNES

## BALANCE BIKES PARTS



### BATTERIES

BATTERIES

- 01 N° BB12-1505 (24V 2.6Ah)
- 02 N° BB16-1505 (24V 5.2Ah)
- 03 N° BB12-1514-01 CHARGEUR DE BATTERIE/ BATTERY CHARGER (Prise européenne/ European plug)

€ 89  
€ 129  
€ 29



### POIGNÉES DE CAOUTCHOUC 19mm (X2) JAUNE/ ROSE/ NOIRE/ ORANGE/ ROUGE/ GRIS/ VERT

SET OF GRIPS YCF 19mm (X2) YELLOW/ PINK/ BLACK/ ORANGE/ RED/ GREY/ GREEN

N° BB12-PPC014-COLOR

€ 12



### PLAQUE AVANT

FRONT PLATE

N° BB12-0212-02-BK

€ 12



### PNEUS

TIRES

- 01 N° BB12-0609-01
- 02 N° BB16-0609-01

€ 15  
€ 19



**CHAMBRE À AIR**  
INNER TUBE

01 N° BB12-0608-01 12x100 € 9  
02 N° BB16-0608-01 16x2.125 € 9

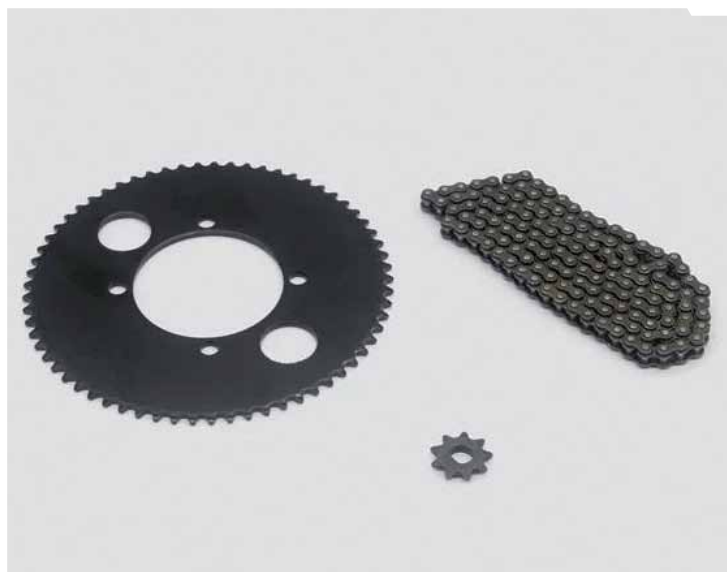

**KIT TRANSMISSION (COURONNE 65T, PIGNON 9T, CHÂÎNE 140T)**  
TRANSMISSION KIT (65T SPROCKET, 9T FRONT SPROCKET, 140T CHAIN)

N° BB16-1808-01 € 19



**CONTRÔLEUR 24V 18A**  
24V 18A CONTROLLER

N° BB16-1502-02 € 29



**TREPIED**  
STAND

N° BB12-TREPIED-GY € 19



DISPONIBLE/ AVAILABLE PAGE 20

€ 1299

SPÉCIFICATIONS

**MOTEUR: MONO CYLINDRE REFROIDISSEMENT À AIR/ AUTOMATIQUE**  
**FOURCHE INVERSÉE 530mm**  
**SUSPENSION ARRIÈRE 200mm**  
**PNEUS AV. & AR.: 2.50/10 - 2.50/10**

SPECIFICATIONS

ENGINE TYPE: SINGLE CYLINDER AIR COOLING/ AUTOMATIC GEAR BOX  
 530mm UPSD FORK  
 200mm REAR SUSPENSION  
 FRONT & REAR TIRES: 2.50/10 - 2.50/10

2026 50AE FUN FANATIC

POINTS FORTS & NOUVEAUTÉS 2026

**MOTEUR 4T 50CC**  
**STARTER AU GUIDON**  
**DÉMARREUR ÉLECTRIQUE**  
**PRISE RAPIDE DE CHARGEUR DE BATTERIE**  
**POIGNÉE GAZ RÉGLABLE**  
**42 KGS SEULEMENT**  
**FREIN AVANT ET FREIN ARRIÈRE HYDRAULIQUE**  
**TÉ FOURCHE SUPÉRIEUR 4 POSITIONS**  
**RÉGLAGE DE LA HAUTEUR POSSIBLE**  
**NOUVEAU GUIDON AVEC POIGNÉES CAOUTCHOUC YCF 19mm**  
**NOUVEAU BRAS OSCILLANT RÉGLABLE (2 POSITIONS)**

HIGHLIGHTS & 2026 NEW FEATURES

50CC 4 STROKE ENGINE  
 START BUTTON  
 ELECTRIC START  
 FAST BATTERY CHARGING  
 ADJUSTABLE THROTTLE  
 ONLY 92 LBS IN WEIGHT  
 HYDRAULIC BRAKE SYSTEM  
 UPPER CLAMP 4 POSITIONS BAR MOUNT  
 ADJUSTABLE HEIGHT  
 NEW HANDLEBAR WITH 19mm YCF RUBBER GRIPS  
 NEW SWING ARM ADJUSTABLE HEIGHT (2 POSITIONS)



STANDARD 550mm/ 21 in.  
LOW 530mm/ 20 in.



 42Kg/ 92 lbs

L : 560mm/ W: 22 in.

870mm/ 34 in.

1270mm/ 50 in.



DISPONIBLE/ AVAILABLE PAGE 20

€ 1699

**SPÉCIFICATIONS**

**MOTEUR: ÉLECTRIQUE 48v**  
**BATTERIE LITHIUM 10ah**  
**FOURCHE INVERSÉE 530mm**  
**SUSPENSION ARRIÈRE 200mm**  
**PNEU AV. & ARR.: 2.50/10 - 2.50/ 10**

**SPECIFICATIONS**

48v ELECTRIC  
 10 Ah LITHIUM BATTERY  
 530mm UPSD FORK  
 200mm REAR SUSPENSION  
 FRONT & REAR TIRES: 2.50/10 - 2.50/ 10

**2026 W50**  
**SILENCE BUILT TO PERFECTION**

**POINTS FORTS & NOUVEAUTÉS 2026**

**MOTEUR ÉLECTRIQUE NÉODYMIUM MAGNET DC 1200W/ 48V**  
**BATTERIE LITHIUM/ TEMPS DE CHARGE 4H**  
**AUTONOMIE 1H30**  
**CHARGEUR LI-ION 110V/ 220V**  
**RÉGLAGE PARENTAL (POTENTIOMÈTRE)**  
**POIGNÉE GAZ INDICATEUR CHARGE BATTERIE**  
**36KG SEULEMENT**  
**RÉGLAGE DU TEMPS DE RÉPONSE À L'ACCÉLÉRATION**  
**FREIN AVANT ET FREIN ARRIÈRE HYDRAULIQUE**  
**VITESSE RÉGLABLE**  
**FREINS À DISQUE AVANT ARRIÈRE AU GUIDON**  
**NOUVEAU GUIDON AVEC POIGNÉES CAOUTCHOUC YCF 19mm**  
**NOUVEAU BRAS OSCILLANT RÉGLABLE (2 POSITIONS)**  
**RÉGLAGE DE LA HAUTEUR POSSIBLE**

**HIGHLIGHTS & 2026 NEW FEATURES**

1200W/ 48V NEODYMIUM MAGNET DC ENGINE  
 LITHIUM BATTERY/ CHARGING TIME 4 HOURS  
 BATTERY LIFE 1H30  
 LI-ION BATTERY CHARGER 110V/ 220V  
 SPEED DIAL (POTENTIOMETER)  
 THROTTLE WITH BATTERY CHARGE INDICATOR  
 ONLY 79 LBS IN WEIGHT  
 ACCELERATION RESPONSE TIME ADJUSTMENT  
 HYDRAULIC BRAKE SYSTEM  
 ADJUSTABLE SPEED POSITION  
 HANDLEBAR FRONT REAR BRAKE DISC  
 NEW HANDLEBAR WITH 19mm YCF RUBBER GRIPS  
 NEW SWING ARM ADJUSTABLE HEIGHT (2 POSITIONS)  
 ADJUSTABLE HEIGHT



STANDARD 550mm/ 21 in.  
LOW 530mm/ 20 in.

 36Kg/ 79 lbs

L : 560mm/ W: 22 in.

870mm/ 34 in.  
1270mm/ 50 in.

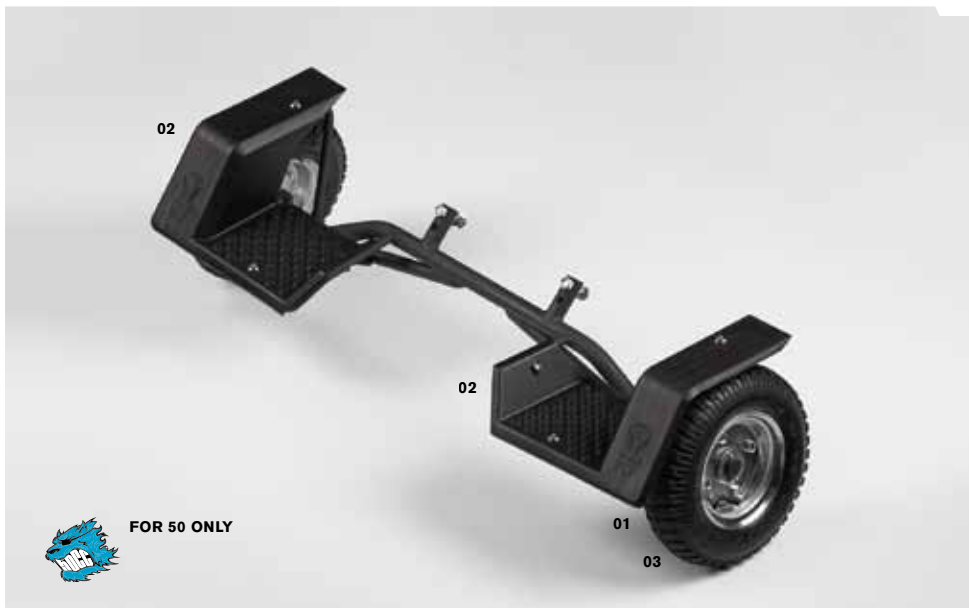

FOR 50 ONLY

**KIT STABILISATEUR POUR YCF 50**  
STABILIZER WHEEL KIT FOR YCF 50

N° YC50-2105

€ 119

**CHAMBRE À AIR POUR KIT STABILISATEUR**  
TUBE FOR STABILIZER WHEEL KIT

03 N° YC50-2106

€ 8

**ROUE POUR KIT STABILISATEUR**  
WHEEL FOR STABILIZER WHEEL KIT

01 N° YC50-2101

€ 25

**GARDE BOUE POUR KIT STABILISATEUR**  
MUDGUARD FOR STABILIZER WHEEL KIT

02 N° YC50-2103 (GAUCHE/ LEFT)  
02 N° YC50-2104 (DROIT/ RIGHT)

€ 25



PAGE 93

PAGE 87

PAGE 87

PAGE 112



PAGE 81

PAGE 93

PAGE 90

PAGE 139

PAGE 117

PAGE 93

PAGE 85



€ 999

NEW  
2026

2026 LITE 88S  
LIGHT IS RIGHT!

#### SPÉCIFICATIONS

**MOTEUR: MONO CYLINDRE 4 TEMPS 88cc**  
**4 VITESSES EMBRAYAGE SEMI AUTOMATIQUE**  
**FOURCHE INVERSÉE 600mm**  
**SUSPENSION ARRIÈRE 265mm**  
**PNEUS AV. & AR. : 250/10 - 300/10**

#### SPECIFICATIONS

ENGINE TYPE: SINGLE CYLINDER 4 STROKE 88cc  
4 GEARS (N1234) WITH AUTOMATIC CLUTCH  
600mm UPSD FORK  
265mm REAR SUSPENSION  
FRONT & REAR TIRES: 250/10 - 300/10

#### POINTS FORTS & NOUVEAUTÉS 2026

**MOTEUR SEMI-AUTOMATIQUE**  
**SELLE BASSE COMPATIBLE PAGE 92**  
**POIGNÉE CAOUTCHOUC YCF**  
**NOUVEL AMORTISSEUR**  
**NOUVELLE FOURCHE INVERSÉE**  
**BRAS OSCILLANT MONO**  
**NOUVEAU CADRE**  
**HYDRAULIC BRAKE SYSTEM**

#### HIGHLIGHTS & 2026 NEW FEATURES

SEMI-AUTOMATIC ENGINE  
COMPATIBLE LOW SEAT PAGE 92  
YCF GRIPS  
NEW SHOCK ABSORBER  
NEW UPSD FRONT FORK  
MONO SWING ARM  
NEW FRAME  
FREIN AVANT ET ARRIÈRE HYDRAULIQUE

# LTE 885



675mm / 26 in.

 60Kg / 132 lbs

L : 760mm / W: 30 in.

1035mm / 41 in.

1460mm / 57 in.



€ 999

NEW  
2026

2026 LITE 125  
LIGHT? YOU BET!

#### SPÉCIFICATIONS

**MOTEUR: MONO CYLINDRE 4 TEMPS 125cc**  
**4 VITESSES EMBRAYAGE**  
**FOURCHE INVERSÉE 660mm**  
**SUSPENSION ARRIÈRE 270mm**  
**PNEUS AV. & AR.: 60/100/14 - 80/100/12**

#### SPECIFICATIONS

ENGINE TYPE: SINGLE CYLINDER 4 STROKE 125cc  
4 GEARS (N1234)  
660mm UPSD FORK  
270mm REAR SUSPENSION  
FRONT & REAR TIRES: 60/100/14 - 80/100/12

#### POINTS FORTS & NOUVEAUTÉS 2026

**EMBRAYAGE MANUEL**  
**SELLE BASSE COMPATIBLE PAGE 92**  
**FILTRE À AIR YCF**  
**POIGNÉE CAOUTCHOUC YCF**  
**NOUVEL AMORTISSEUR**  
**NOUVELLE FOURCHE INVERSÉE**  
**BRAS OSCILLANT MONO**  
**NOUVEAU CADRE**  
**FREIN AVANT ET ARRIÈRE HYDRAULIQUE**

#### HIGHLIGHTS & 2026 NEW FEATURES

MANUAL CLUTCH  
COMPATIBLE LOW SEAT PAGE 92  
YCF AIR FILTER  
YCF GRIPS  
NEW SHOCK ABSORBER  
NEW UPSD FRONT FORK  
MONO SWING ARM  
NEW FRAME  
HYDRAULIC BRAKE SYSTEM

# ME 125



725mm/ 29 in.

 63Kg/ 139 lbs

L : 760mm/ W: 30 in.

1140mm/ 45 in.

1610mm/ 63 in.



€ 1399

NEW  
2026

2026 LITE 150  
LIGHT? YOU BET!

#### SPÉCIFICATIONS

**MOTEUR: MONO CYLINDRE 4 TEMPS 150cc**  
**4 VITESSES EMBRAYAGE (N1234)**  
**FOURCHE INVERSÉE 735mm**  
**SUSPENSION ARRIÈRE 330m**  
**PNEUS AV. & AR. : 60/100/14 - 80/100/12**

#### SPECIFICATIONS

ENGINE TYPE: SINGLE CYLINDER 4 STROKE 150cc  
4 GEARS (N1234)  
735mm UPSD FORK  
330mm REAR SUSPENSION  
FRONT & REAR TIRES: 60/100/14 - 80/100/12

#### POINTS FORTS & NOUVEAUTÉS 2026

**EMBRAYAGE MANUEL**  
**POIGNÉE CAOUTCHOUC YCF**  
**NOUVELLE FOURCHE INVERSÉE**  
**BRAS OSCILLANT MONO**  
**FREIN AVANT ET ARRIÈRE HYDRAULIQUE**  
**FILTRE À AIR YCF**  
**NOUVEL AMORTISSEUR**

#### HIGHLIGHTS & 2026 NEW FEATURES

MANUAL CLUTCH  
YCF GRIPS  
NEW UPSD FRONT FORK  
MONO SWING ARM  
HYDRAULIC BRAKE SYSTEM  
YCF AIR FILTER  
NEW SHOCK ABSORBER

# VTE 150



810mm / 32 in.

 63Kg / 139 lbs

L : 760mm / W: 30 in.

1190mm / 47 in.

1655mm / 65 in.



€ 1499

NEW  
2026

2026 LITE 150 L  
EASY TO PICK UP

#### SPECIFICATIONS

**MOTEUR: MONO CYLINDRE 4 TEMPS 150cc**  
**4 VITESSES EMBRAYAGE**  
**FOURCHE INVERSÉE 735mm**  
**SUSPENSION ARRIÈRE 330mm**  
**PNEUS AV. & AR. : 70/100/17 - 90/100/14**

#### SPECIFICATIONS

ENGINE TYPE: SINGLE CYLINDER 4 STROKE 150cc  
4 GEARS (N1234)  
735mm UPSD FORK  
330mm REAR SUSPENSION  
FRONT & REAR TIRES: 70/100/17 - 90/100/14

#### POINTS FORTS & NOUVEAUTÉS 2026

**EMBRAYAGE MANUEL**  
**POIGNÉE CAOUTCHOUC YCF**  
**NOUVELLE FOURCHE INVERSÉE**  
**BRAS OSCILLANT MONO**  
**FREIN AVANT ET ARRIÈRE HYDRAULIQUE**  
**FILTRE À AIR YCF**  
**NOUVEL AMORTISSEUR**

#### HIGHLIGHTS & 2026 NEW FEATURES

MANUAL CLUTCH  
YCF GRIPS  
NEW UPSD FRONT FORK  
MONO SWING ARM  
HYDRAULIC BRAKE SYSTEM  
YCF AIR FILTER  
NEW SHOCK ABSORBER

# YAMAHA 150L



860mm / 33 in.

 63Kg / 139 lbs

L : 760mm / W: 30 in.

1255mm / 49 in.

1810mm / 71 in.



€ 1599

#### SPÉCIFICATIONS

**MOTEUR: MONO CYLINDRE 4 TEMPS 88cc**  
**4 VITESSES EMBRAYAGE SEMI AUTOMATIQUE**  
**FOURCHE INVERSÉE 600mm**  
**SUSPENSION ARRIÈRE RÉGLABLE 265mm**  
**PNEUS AV. & AR.: 60/100/12 - 300/10**

#### SPECIFICATIONS

ENGINE TYPE: SINGLE CYLINDER 4 STROKE 88cc  
4 GEARS (N1234) WITH AUTOMATIC CLUTCH  
600mm UPSD FORK  
265mm ADJUSTABLE REAR SUSPENSION  
FRONT & REAR TIRES: 60/100/12 - 300/10

## 2026 START 88SE MAGIC BUTTON

#### POINTS FORTS & NOUVEAUTÉS 2026

**DÉMARREUR ÉLECTRIQUE**  
**SEMI-AUTOMATIQUE**  
**POIGNÉE DE GAZ RÉGLABLE**  
**BOUTON DE DÉMARREUR ÉTANCHE**  
**SELLE BASSE COMPATIBLE PAGE 92**  
**FILTRE À AIR YCF**  
**POIGNÉE CAOUTCHOUC YCF**  
**TÉ FOURCHE SUPÉRIEUR 3 POSITIONS**  
**RÉGLAGE DE LA HAUTEUR POSSIBLE**  
**NOUVEAU BRAS OSCILLANT RÉGLABLE (2 POSITIONS)**

#### HIGHLIGHTS & 2026 NEW FEATURES

ELECTRIC STARTER  
SEMI-AUTOMATIC  
ADJUSTABLE THROTTLE  
WATERPROOF START BUTTON  
COMPATIBLE LOW SEAT PAGE 92  
YCF AIR FILTER  
YCF GRIPS  
UPPER CLAMP 3 POSITIONS BAR MOUNT  
ADJUSTABLE HEIGHT  
NEW SWING ARM ADJUSTABLE HEIGHT (2 POSITIONS)

# START 88<sup>5</sup>



STANDARD 705mm/ 28 in.  
LOW 690mm/ 27 in.

 65Kg/ 143 lbs

L : 760mm/ W: 30 in.

1045mm/ 41 in.

1460mm/ 57 in.



€ 2299

#### SPÉCIFICATIONS

**MOTEUR: ÉLECTRIQUE 60V**  
**BATTERIE LITHIUM 20Ah**  
**FOURCHE INVERSÉE 600mm**  
**SUSPENSION ARRIÈRE RÉGLABLE 265mm**  
**PNEUS AV. & AR.: 60/100/12 - 300/10**

#### SPECIFICATIONS

ENGINE TYPE: 60V ELECTRIC  
20Ah LITHIUM BATTERY  
600mm UPSD FORK  
265mm ADJUSTABLE REAR SUSPENSION  
FRONT & REAR TIRES: 60/100/12 - 300/10

## 2026 W88 THE NEW ERA OF ELECTRIC

#### POINTS FORTS & NOUVEAUTÉS 2026

**MOTEUR BRUSHLESS 60V**  
**BATTERIE LITHIUM/ TEMPS DE CHARGE 4H**  
**AUTONOMIE ENTRE 1H00 ET 1H30**  
**CHARGEUR RAPIDE LI-ION 110V/ 240V**  
**45 KG SEULEMENT**  
**RÉGLAGE 3 VITESSES**  
**SELLE BASSE COMPATIBLE PAGE 92**  
**RÉGLAGE DE LA HAUTEUR POSSIBLE**  
**CHAÎNE-COURONNE-PSB EN 420**  
**NOUVEAU BRAS OSCILLANT RÉGLABLE (2 POSITIONS)**

#### HIGHLIGHTS & 2026 NEW FEATURES

60V BRUSHLESS ENGINE (BDLC)  
LITHIUM BATTERY/ CHARGING TIME 4 HOURS  
BATTERY LIFE BETWEEN 1H AND 1H30  
LI-ION BATTERY FAST CHARGER 110V/ 240V  
ONLY 99 LBS IN WEIGHT  
ADJUSTABLE 3 SPEEDS  
COMPATIBLE LOW SEAT PAGE 92  
ADJUSTABLE HEIGHT  
SPROCKET-CHAIN 420  
NEW SWING ARM ADJUSTABLE HEIGHT (2 POSITIONS)

# START WEBB

STANDARD 705mm/ 28 in.  
LOW 690mm/ 27 in.



 45Kg/ 99 lbs

L : 760mm/ W: 30 in.

1040mm/ 41 in.

1460mm/ 57 in.



€ 1699

#### SPÉCIFICATIONS

**MOTEUR: MONO CYLINDRE 4 TEMPS 125cc**  
**4 VITESSES EMBRAYAGE SEMI AUTOMATIQUE**  
**FOURCHE INVERSÉE 660mm**  
**SUSPENSION ARRIÈRE RÉGLABLE 270mm**  
**PNEUS AV. & AR. : 60/100/14 - 80/100/12**

#### SPECIFICATIONS

ENGINE TYPE: SINGLE CYLINDER 4 STROKE 125cc  
4 GEARS (N1234) WITH AUTOMATIC CLUTCH  
660mm UPSD FORK  
270mm ADJUSTABLE REAR SUSPENSION  
FRONT & REAR TIRES: 60/100/14 - 80/100/12

## 2026 START 125SE THE ULTIMATE BATTLE MACHINE

#### POINTS FORTS & NOUVEAUTÉS 2026

**DÉMARREUR ÉLECTRIQUE**  
**SEMI-AUTOMATIQUE**  
**POIGNÉE DE GAZ RÉGLABLE**  
**SELLE BASSE COMPATIBLE PAGE 92**  
**FILTRE À AIR YCF**  
**POIGNÉE CAOUTCHOUC YCF**  
**TÉ FOURCHE SUPÉRIEUR 3 POSITIONS**  
**NOUVEAU BRAS OSCILLANT RÉGLABLE (2 POSITIONS)**  
**RÉGLAGE DE LA HAUTEUR POSSIBLE**

#### HIGHLIGHTS & 2026 NEW FEATURES

ELECTRIC START  
SEMI-AUTOMATIC  
ADJUSTABLE THROTTLE  
COMPATIBLE LOW SEAT PAGE 92  
YCF AIR FILTER  
YCF GRIPS  
UPPER CLAMP 3 POSITIONS BAR MOUNT  
NEW SWING ARM ADJUSTABLE HEIGHT (2 POSITIONS)  
ADJUSTABLE HEIGHT

# START 125<sup>LS</sup>



STANDARD 745mm/ 29 in.  
LOW 720mm/ 28 in.

 69Kg/ 152 lbs

L : 760mm/ W: 30 in..

1120mm/ 44 in.

1595mm/ 62 in.



€ 1899

#### SPÉCIFICATIONS

**MOTEUR: MONOCYLINDRE 4 TEMPS**  
150cc/ 4 VITESSES (N1234)  
**FOURCHE INVERSÉE 735mm**  
**SUSPENSION ARRIÈRE RÉGLABLE 330mm**  
**PNEUS AV. & AR. : 60/100/14 - 80/100/12**

#### SPECIFICATIONS

ENGINE TYPE: SINGLE CYLINDER 4 STROKE  
150cc/ 4 GEARS (N1234)  
735mm UPSD FORK  
330mm ADJUSTABLE REAR SUSPENSION  
FRONT & REAR TIRES: 60/100/14 - 80/100/12

## 2026 PILOT 150 THE ULTIMATE F150

#### POINTS FORTS & NOUVEAUTÉS 2026

**POIGNÉE CAOUTCHOUC YCF**  
**TÉ FOURCHE SUPÉRIEUR 3 POSITIONS**  
**CARBURATEUR NIBBI PE24SP**  
**BOÎTE À AIR**  
**SILENCIEUX ANTI-BRUIT**  
**NOUVEAU KICK**  
**LEVIER DE FREIN PLIABLE**

#### HIGHLIGHTS & 2026 NEW FEATURES

YCF GRIPS  
UPPER CLAMP 3 POSITIONS BAR MOUNT  
NIBBI PE24SP CARBURETOR  
AIR BOX  
MUFFLER NOISE KILLER  
NEW KICKSTART  
FOLDABLE FRONT BRAKE LEVER

# PILOT 150



800mm / 31 in.

 70Kg / 154 lbs

L : 760mm / W: 30 in.

1170mm / 46 in.

1650mm / 65 in.



€ 2499

#### SPÉCIFICATIONS

**MOTEUR: MONOCYLINDRE 4 TEMPS**  
**150cc TYPE KLX/ 4 VITESSES**  
**FOURCHE INVERSÉE RÉGLABLE 735mm**  
**SUSPENSION ARRIÈRE RÉGLABLE 330mm**  
**PNEUS AV. & AR. : 60/100/14 - 80/100/12 ARRO®**

#### SPECIFICATIONS

ENGINE TYPE: SINGLE CYLINDER 4 STROKE  
150cc KLX TYPE/ 4 GEARS (N1234)  
735mm ADJUSTABLE UPSD FORK  
330mm ADJUSTABLE REAR SUSPENSION  
FRONT & REAR TIRES: 60/100/14 - 80/100/12 ARRO®

## 2026 FACTORY 150 SP2 RACE READY

#### POINTS FORTS & NOUVEAUTÉS 2026

**MOYEURS AVANT/ ARRIÈRE ALUMINIUM CNC**  
**COURONNE 5 TROUS**  
**PNEUS ARRO® AVANT/ ARRIÈRE**  
**CERCEAU DE ROUE ALUMINIUM 7116 NOIR**  
**BAVETTE AMORTISSEUR**  
**TÉ FOURCHE SUPÉRIEUR 3 POSITIONS**  
**BRAS OSCILLANT ALUMINIUM 420mm**  
**CARBURATEUR NIBBI PE24SP**  
**SILENCIEUX ANTI-BRUIT**  
**NOUVEAU KICK**  
**PROTÈGE DISQUE ARRIÈRE**  
**BOÎTE À AIR**

#### HIGHLIGHTS & 2026 NEW FEATURES

ALUMINUM CNC FRONT/ REAR HUBS  
5 BOLT SPROCKET  
FRONT/ REAR ARRO® TIRES  
ALUMINIUM 7116 BLACK RIMS  
MUD FLAP  
UPPER CLAMP 3 POSITIONS BAR MOUNT  
420mm ALUMINIUM SWING ARM  
NIBBI PE24SP CARBURETOR  
MUFFLER NOISE KILLER  
NEW KICKSTART  
REAR DISC GUARD  
AIR BOX

# FACTORY 150 SP2



810mm / 32 in.

 73Kg / 161 lbs

L : 760mm / W: 30 in..

1190mm / 47 in.

1670mm / 66 in.



€ 3499

#### SPÉCIFICATIONS

**MOTEUR: MONO CYLINDRE 4T, 4 SOUPAPES 190cc**  
**DAYTONA® ANIMA® / 4 VITESSES**  
**FOURCHE ENGI® INVERSÉE RÉGLABLE 800mm**  
**SUSPENSION ARRIÈRE ENGI® RÉGLABLE 335mm**  
**PNEUS AV. & AR. ARRO® : 60/100/14 - 80/100/12**  
**CARBURATEUR NIBBI® 28**

#### SPECIFICATIONS

ENGINE TYPE: DAYTONA® ANIMA® SINGLE CYLINDER 4V  
4 STROKE 190cc/ 4 GEARS (N1234)  
800mm ENGI® UPSD ADJUSTABLE FORK  
335mm ENGI® ADJUSTABLE REAR SUSPENSION  
FRONT & REAR ARRO® TIRES: 60/100/14 - 80/100/12  
NIBBI® 28 CARBURETOR

**DAYTONA ENGI® ARRO™**

## 2026 FACTORY 190 SP3 DAYTONA CATCH ME IF YOU CAN

#### POINTS FORTS & NOUVEAUTÉS 2026

**BRAS OSCILLANT 460mm**  
**TÉ 170mm**  
**MOYEURS AVANT/ ARRIÈRE ALUMINIUM CNC**  
**GUIDON YCF 28,6MM**  
**REPOSE PIED INOX**  
**PÉDALE DE FREIN ALUMINIUM**  
**TÉ FOURCHE SUPÉRIEUR 3 POSITIONS**  
**SILENCIEUX ANTI-BRUIT**  
**NOUVEAU KICK**  
**PROTÈGE DISQUE ARRIÈRE**  
**BOÎTE À AIR**

#### HIGHLIGHTS & 2026 NEW FEATURES

460mm SWINGARM  
170mm TRIPLE CLAMPS  
ALUMINIUM CNC FRONT/ REAR HUBS  
YCF FAT BAR 28,6mm HANDLEBAR  
INOX FOOT PEGS  
ALUMINIUM BRAKE PEDAL  
UPPER CLAMP 3 POSITIONS BAR MOUNT  
MUFFLER NOISE KILLER  
NEW KICKSTART  
REAR DISC GUARD  
AIR BOX

# FACTORY 190SP3

DAYTONA®



850mm / 33 in.

 73Kg / 161 lbs

L : 760mm / W: 30 in.

1195mm / 47 in.

1670mm / 66 in.



€ 2199

#### SPÉCIFICATIONS

**MOTEUR: MONO CYLINDRE**  
**4 TEMPS 150cc/ 4 VITESSES**  
**FOURCHE INVERSÉE 785mm**  
**SUSPENSION ARRIÈRE RÉGLABLE 355mm**  
**PNEUS AV. & AR. : 70/100/17 - 90/100/14**

#### SPECIFICATIONS

ENGINE TYPE: SINGLE CYLINDER  
4 STROKE 150cc/ 4 GEARS (N1234)  
FORK: 785mm UPSD FORK  
REAR SUSPENSION: 355mm ADJUSTABLE  
FRONT & REAR TIRES: 70/100/17 - 90/100/14

## 2026 BIGY 150 BIGGER! FASTER! STRONGER!

#### POINTS FORTS & NOUVEAUTÉS 2026

**ROUE AVANT 17"/ ARRIÈRE 14"**  
**BAVETTE AMORTISSEUR**  
**LEVIER DE FREIN PLIABLE**  
**TÉ FOURCHE SUPÉRIEUR 3 POSITIONS**  
**CARBURATEUR NIBBI® PE24**  
**SILENCIEUX ANTI-BRUIT**  
**NOUVEAU KICK**  
**BOÎTE À AIR**

#### HIGHLIGHTS & 2026 NEW FEATURES

FRONT 17"/ REAR 14" WHEEL  
MUD FLAP  
FOLDABLE FRONT BRAKE LEVER  
UPPER CLAMP 3 POSITIONS BAR MOUNT  
NIBBI® PE24 CARBURETOR  
MUFFLER NOISE KILLER  
NEW KICKSTART  
AIR BOX

# bigY 150



880mm/ 34 in.

 81Kg/ 178 lbs

L : 780mm/ W: 31 in..

1300mm/ 51 in.

1875mm/ 74 in.



€ 2599

#### SPÉCIFICATIONS

**MOTEUR: MONOCYLINDRE 4 TEMPS**  
**150cc YX TYPE KLX/ 4 VITESSES (N1234)**  
**FOURCHE INVERSÉE RÉGLABLE 800mm**  
**SUSPENSION ARRIÈRE RÉGLABLE 355mm**  
**PNEUS AV. & AR.: 70/100/17 - 90/100/14**  
**CARBURATEUR NIBBI® PE24**

#### SPECIFICATIONS

ENGINE TYPE: SINGLE CYLINDER 4 STROKE  
150cc YX KLX TYPE/ 4 GEARS (N1234)  
800mm ADJUSTABLE UPSD FORK  
355mm ADJUSTABLE REAR SUSPENSION  
FRONT & REAR TIRES: 70/100/17 - 90/100/14  
NIBBI® PE24 CARBURETOR

## 2026 BIGY 150 FACTORY FAST & EASY

#### POINTS FORTS & NOUVEAUTÉS 2026

**ROUE AVANT 17"/ ARRIÈRE 14"**  
**JANTES ALUMINIUM 7116**  
**MOYEURS AVANT/ ARRIÈRE ALUMINIUM CNC**  
**BAVETTE AMORTISSEUR**  
**REPOSE PIED INOX**  
**PÉDALE DE FREIN ALUMINIUM**  
**TÉ FOURCHE SUPÉRIEUR 3 POSITIONS**  
**BOÎTE À AIR**  
**SILENCIEUX ANTI-BRUIT**  
**NOUVEAU KICK**

#### HIGHLIGHTS & 2026 NEW FEATURES

FRONT 17"/ REAR 14" WHEEL  
ALUMINIUM 7116 RIMS  
ALUMINIUM FRONT/ REAR CNC HUBS  
MUD FLAP  
INOX FOOT PEGS  
ALUMINIUM BRAKE PEDAL  
UPPER CLAMP 3 POSITIONS BAR MOUNT  
AIR BOX  
MUFFLER NOISE KILLER  
NEW KICKSTART

# BEY 150 FACTORY



890mm/ 35 in.

 84Kg/ 185 lbs

L : 780mm/ W: 31 in.

1305mm/ 51 in.

1880mm/ 74 in.



€ 3699

#### SPÉCIFICATIONS

**MOTEUR: MONO CYLINDRE 4T, 4 SOUPAPES 190cc**  
**DAYTONA® ANIMA® / 4 VITESSES**  
**MOTEUR 4 VITESSES**  
**FOURCHE ENGI® INVERSÉE RÉGLABLE 800mm**  
**SUSPENSION ARRIÈRE ENGI® RÉGLABLE 355mm**  
**PNEUS AV. & AR.: 70/100/19 - 90/100/16**  
**CARBURATEUR NIBBI® 28**

#### SPECIFICATIONS

ENGINE TYPE: DAYTONA® ANIMA® SINGLE CYLINDER 4V  
 4 STROKE 190cc/ 4 GEARS (N1234)  
 4 SPEED ENGINE  
 800mm ENGI® UPSD ADJUSTABLE FORK  
 355mm ENGI® ADJUSTABLE REAR SUSPENSION  
 FRONT & REAR TIRES: 70/100/19 - 90/100/16  
 NIBBI® 28 CARBURETOR

**DAYTONA ENGI® ARRO™**

## 2026 BIGY 190 FACTORY DAYTONA XL FIRST TO THE FINISH LINE

#### POINTS FORTS & NOUVEAUTÉS 2026

**ROUE AVANT 19" / ARRIÈRE 16"**  
**SURMOUSSE DE GUIDON CAOUTCHOUC 3D**  
**MOTEUR 4 VITESSES DAYTONA**  
**BRAS OSCILLANT ALUMINIUM**  
**REPOSE PIED INOX**  
**BAVETTE AMORTISSEUR**  
**GUIDON YCF 28,6MM**  
**TÉ FOURCHE SUPÉRIEUR 3 POSITIONS**  
**BOÎTE À AIR**  
**SILENCIEUX ANTI-BRUIT**  
**NOUVEAU KICK**  
**PROTÈGE DISQUE ARRIÈRE**

#### HIGHLIGHTS & 2026 NEW FEATURES

FRONT WHEEL 19" & REAR 16"  
 RUBBER BAR PAD  
 DAYTONA 4 SPEED ENGINE  
 ALUMINUM SWING ARM  
 INOX FOOTPEGS  
 MUD FLAP  
 YCF FAT BAR 28.6mm HANDLEBAR  
 UPPER CLAMP 3 POSITIONS BAR MOUNT  
 AIR BOX  
 MUFFLER NOISE KILLER  
 NEW KICKSTART  
 REAR DISC GUARD

**bigX<sup>XL</sup> 190**  
**FACTORY**

**DAYTONA**



910 mm/ 36 in.

 **88,90Kg/ 195 lbs**

L : 780mm/ W: 31 in.

1325mm/ 52 in.

1945mm/ 76 in.



€ 1999

**SPÉCIFICATIONS**

**MOTEUR: MONO CYLINDRE 4 TEMPS 125cc**  
**4 VITESSES EMBRAYAGE**  
**FOURCHE INVERSÉE 660mm**  
**SUSPENSION ARRIÈRE RÉGLABLE 270mm**  
**PNEUS AV. & AR.: 100/90/12 - 120/80/12**

**SPECIFICATIONS**

ENGINE TYPE: SINGLE CYLINDER 4 STROKE 125cc  
 4 GEARS (N1234)  
 660mm UPSD FORK  
 270mm ADJUSTABLE REAR SUSPENSION  
 FRONT & REAR TIRES: 100/90/12 - 120/80/12

**2026 SM 125  
 SUPERMOTO, SUPER FUN!**

**POINTS FORTS & NOUVEAUTÉS 2026**

**MOTEUR 125 ZONGSHEN FIDDY RACER**  
**ROUES YCF**  
**SELLE BASSE COMPATIBLE PAGE 92**  
**TÉ FOURCHE SUPÉRIEUR 3 POSITIONS**  
**CARBURATEUR NIBBI PE24SP**  
**NOUVEAU BRAS OSCILLANT RÉGLABLE (2 POSITIONS)**  
**RÉGLAGE DE HAUTEUR POSSIBLE**  
**NOUVEAU KICK**  
**FILTRE À AIR YCF**  
**POIGNÉE CAOUTCHOUC YCF**

**HIGHLIGHTS & 2026 NEW FEATURES**

ZONGSHEN ENGINE 125 FIDDY RACER  
 YCF WHEELS  
 COMPATIBLE LOW SEAT PAGE 92  
 UPPER CLAMP 3 POSITIONS BAR MOUNT  
 NIBBI PE24SP CARBURETOR  
 NEW SWING ARM ADJUSTABLE HEIGHT (2 POSITIONS)  
 ADJUSTABLE HEIGHT  
 NEW KICKSTART  
 YCF AIR FILTER  
 YCF RUBBER GRIP

# 125



STANDARD 760mm/ 30 in.  
LOW 740mm/ 29 in.

 69Kg/ 152 lbs

L : 760mm/ W: 30 in.

1120mm/ 44 in.

1620mm/ 64 in.



€ 2299

#### SPÉCIFICATIONS

**MOTEUR: MONO CYLINDRE**  
**4 TEMPS 155cc ZONGSHEN/ 4 VITESSES (N1234)**  
**FOURCHE INVERSÉE 735mm**  
**SUSPENSION ARRIÈRE RÉGLABLE 310mm**  
**PNEUS AV. & AR.: 100/90/12 - 120/80/12**

#### SPECIFICATIONS

ENGINE TYPE: SINGLE CYLINDER  
4 STROKE ZONGSHEN 155cc/ 4 GEARS (N1234)  
735mm UPSD FORK  
310mm ADJUSTABLE REAR SUSPENSION  
FRONT & REAR TIRES: 100/90/12 - 120/80/12

## 2026 SM 155 ADRENALINE RUSH

#### POINTS FORTS & NOUVEAUTÉS 2026

**MOTEUR ZONGSHEN® W155**  
**ROUES YCF**  
**FOURCHE RÉGLABLE**  
**TÉ FOURCHE SUPÉRIEUR 3 POSITIONS**  
**CARBURATEUR NIBBI PE24SP**  
**NOUVELLE BOÎTE À AIR**  
**NOUVEAU KICK**

#### HIGHLIGHTS & 2026 NEW FEATURES

ZONGSHEN® ENGINE W155  
YCF WHEELS  
ADJUSTABLE FRONT FORK  
UPPER CLAMP 3 POSITIONS BAR MOUNT  
NIBBI PE24SP CARBURETOR  
NEW AIR BOX  
NEW KICKSTART

# AM1 155



805mm/ 32 in.

 70Kg/ 154 lbs

L : 760mm/ W: 30 in.

1170mm/ 46 in.

1680mm/ 66 in.



€ 3399

**SPÉCIFICATIONS**

**MOTEUR: MONO CYLINDRE 4T, 4 SOUPAPES 190cc**  
**DAYTONA® ANIMA® / 4 VITESSES (N1234)**  
**FOURCHE ENGI® INVERSÉE RÉGLABLE 735mm**  
**SUSPENSION ARRIÈRE DNM® RÉGLABLE 310mm**  
**PNEUS AV. & AR. 100/90/12 - 120/80/12**  
**CARBURATEUR NIBBI® PE28**

**SPECIFICATIONS**

ENGINE TYPE: DAYTONA® ANIMA® SINGLE CYLINDER 4V  
 4 STROKE 190cc/ 4 GEARS (N1234)  
 735mm ENGI® UPSD ADJUSTABLE FORK  
 310mm DNM® ADJUSTABLE REAR SUSPENSION  
 FRONT & REAR TIRES: 100/90/12 - 120/80/12  
 NIBBI® PE28 CARBURETOR

**DAYTONA ENGI®**

**2026 SM 190 DAYTONA**  
**CATCH ME IF YOU CAN (ON ROAD)**

**POINTS FORTS & NOUVEAUTÉS 2026**

**ROUES YCF**  
**AMORTISSEUR DNM**  
**MAÎTRE CYLINDRE AVANT RACING**  
**KIT FREIN RADIAL AVANT ET ARRIÈRE**  
**DISQUE FLOTTANT 220MM**  
**TÉ FOURCHE SUPÉRIEUR 3 POSITIONS**  
**LIGNE D'ÉCHAPPEMENT ANTI-BRUIT DOUBLE SORTIE**  
**NOUVELLE BOÎTE À AIR**  
**NOUVEAU KICK**

**HIGHLIGHTS & 2026 NEW FEATURES**

YCF WHEELS  
 DNM SHOCK ABSORBER  
 FRONT RACING MASTER CYLINDER  
 FRONT AND REAR RADIAL BRAKE KIT  
 SEMI FLOATING BRAKE ROTOR 220MM  
 UPPER CLAMP 3 POSITIONS BAR MOUNT  
 COMPLETE NOISE KILLER EXHAUST TWIN  
 NEW AIR BOX  
 NEW KICKSTART

**190**

**DAYTONA**



805mm / 32 in.

 70Kg / 154 lbs

L : 760mm / W: 30 in.

1170mm / 46 in.

1680mm / 66 in.



**€ 2999**

**SPÉCIFICATIONS**

**MOTEUR :**  
**MONO CYLINDRE 4T ZONGSHEN® 125CC FIDDY RACER**  
**FOURCHE INVERSÉE YCF® NON RÉGLABLE 650MM**  
**AMORTISSEUR YCF® RÉGLABLE DÉTENTE 310MM**  
**PNEUS AV & AR 100/90/12 - 120/80/12**  
**ROUES YCF® ALUMINIUM AV & AR 2.15/12 & 2.75/12**  
**TÉ DE FOURCHE 160MM**  
**CARBURATEUR NIBBI® PE24**

**SPECIFICATIONS**

**ENGINE TYPE :**  
 ZONGSHEN® 125cc FIDDY RACER  
 YCF® 650MM NO ADJUSTABLE FRONT FORK  
 310MM YCF® ADJUSTABLE REBOUND SHOCK ABSORBER  
 TIRES FRONT & REAR 100/90-12 & 120/80/12  
 YCF® ALUMINUM WHEEL 2.15/12 FRONT & 2.75/12 REAR  
 160MM TRIPLE CLAMP  
 CARBURETOR NIBBI® PE24

**2026 GP 124 WARM-UP**

**POINTS FORTS & NOUVEAUTÉS 2026**

**CADRE ET BOUCLE ARRIÈRE ALUMINIUM**  
**BRAS OSCILLANT ALUMINIUM**  
**DISQUE FREIN AVANT FLOTTANT 220MM**  
**ÉTRIER FREIN AVANT RADIAL 4 PISTONS**  
**CARÉNAGE ABS**  
**COMMANDES RECLUÉES RÉGLABLES**  
**GUIDON BRACELET RÉGLABLE**  
**DIABOLOS DE BÉQUILLE AVANT & ARRIÈRE**  
**TENDEURS DE CHAÎNE MINI GP**  
**BOUCHON RÉSERVOIR ALUMINIUM FERMETURE RAPIDE**  
**ÉCHAPPEMENT BAS**  
**SABOT RÉCUPÉRATEUR D'HUILE ÉTANCHE**  
**LIVRÉE AVEC UNE BÉQUILLE DE STAND ARRIÈRE**  
**NOUVELLE BOÎTE À AIR**  
**NOUVEAU KICK**

**HIGHLIGHTS & 2026 NEW FEATURES**

ALUMINUM FRAME AND SUBFRAME  
 ALUMINUM SWING ARM  
 220MM FLOATING FRONT DISC  
 RADIAL 4-PISTON FRONT BRAKE CALIPER  
 ABS FAIRING  
 FULLY ADJUSTABLE REARSETS  
 FULLY ADJUSTABLE HANDLEBAR  
 FRONT & REAR SPOOL  
 MINI GP BLOCK AXLE  
 QUICK RELEASE GAS CAP  
 BELLY EXHAUST SYSTEM  
 BELLY PAN  
 INCLUDE REAR BIKE STAND  
 NEW AIR BOX  
 NEW KICKSTART



# GP124



 72,4Kg / 159 lbs

L : 680mm / W: 27 in.

1170mm / 46 in.

1665mm / 65 in.



€ 3499

#### SPÉCIFICATIONS

**MOTEUR: MONO CYLINDRE 4T, ZONGSHEN® 155cc**  
**MONO CYLINDRE 4T, 4 VITESSES (N1234)**  
**FOURCHE INVERSÉE YCF® RÉGLABLE**  
**COMPRESSION/ DÉTENTE 650MM**  
**AMORTISSEUR DNM RÉGLABLE COMPRESSION/**  
**DÉTENTE 310MM**  
**PNEUS AV & AR 100/90/12 - 120/80/12**  
**ROUES YCF® ALUMINIUM AV & AR 2.15/12 & 2.75/12**  
**TÉ DE FOURCHE 160MM**  
**CARBURETEUR NIBBI® PE24**

#### SPECIFICATIONS

ENGINE TYPE : ZONGSHEN® 155cc  
 4 SPEED (N1234)  
 YCF® 650MM FULLY ADJUSTABLE COMPRESSION/  
 REBOUND FRONT FORK  
 DNM ADJUSTABLE SHOCK ABSORBER WITH  
 COMPRESSION/REBOUND SETTINGS, 310MM  
 TIRES FRONT & REAR 100/90-12 & 120/80/12  
 YCF® ALUMINIUM WHEEL 2.15/12 FRONT & 2.75/12 REAR  
 160MM TRIPLE CLAMP  
 CARBURETOR NIBBI® PE24

## 2026 GP 157 APEX

#### POINTS FORTS & NOUVEAUTÉS 2026

**CADRE ET BOUCLE ARRIÈRE ALUMINIUM**  
**BRAS OSCILLANT ALUMINIUM**  
**DISQUE FREIN AVANT FLOTTANT 220MM**  
**ÉTRIER FREIN AVANT RADIAL 4 PISTONS**  
**CARÉNAGE ABS**  
**COMMANDES REÇULÉES RÉGLABLES**  
**GUIDON BRACELET RÉGLABLE**  
**DIABOLOS DE BÉQUILLE AVANT & ARRIÈRE**  
**TENDEURS DE CHAÎNE MINI GP**  
**BOUCHON RÉSERVOIR ALUMINIUM FERMETURE RAPIDE**  
**ÉCHAPPEMENT BAS**  
**SABOT RÉCUPERATEUR D'HUILE ÉTANCHE**  
**LIVRÉE AVEC UNE BÉQUILLE DE STAND ARRIÈRE**  
**NOUVELLE BOÎTE À AIR**  
**NOUVEAU KICK**

#### HIGHLIGHTS & 2026 NEW FEATURES

ALUMINIUM FRAME AND SUBFRAME  
 ALUMINIUM SWING ARM  
 220MM FLOATING FRONT DISC  
 RADIAL 4-PISTON FRONT BRAKE CALIPER  
 ABS FAIRING  
 FULLY ADJUSTABLE REARSETS  
 FULLY ADJUSTABLE HANDLEBAR  
 FRONT & REAR SPOOL  
 MINI GP BLOCK AXLE  
 QUICK RELEASE GAS CAP  
 BELLY EXHAUST SYSTEM  
 BELLY PAN  
 INCLUDE REAR STAND  
 NEW AIR BOX  
 NEW KICKSTART



# GP 157



 75,5Kg / 165 lbs

L : 680mm / W : 27 in.

1170mm / 46 in.

1665mm / 65 in.



€ 4499

## 2026 GP 187 DAYTONA HOLESHOT

### SPÉCIFICATIONS

**MOTEUR: DAYTONA® ANIMA/ 4 VITESSES (N1234)**  
**MONO CYLINDRE 4T, 4 SOUPAPES 190cc**  
**FOURCHE INVERSÉE YCF® RÉGLABLE COMPRESSION/ DÉTENTE 650MM**  
**AMORTISSEUR DNM® RÉGLABLE COMPRESSION/ DÉTENTE 310MM**  
**PNEUS AV & AR 100/90/12 - 120/80/12**  
**ROUES YCF® ALUMINIUM AV & AR 2.15/12 & 2.75/12**  
**TÉ DE FOURCHE 160MM**  
**CARBURATEUR NIBBI® PE28**

### SPECIFICATIONS

ENGINE TYPE : DAYTONA® ANIMA SINGLE CYLINDER 4V  
 4 STROKE 190cc/ 4 SPEED (N1234)  
 YCF® 650MM FULLY ADJUSTABLE COMPRESSION/  
 REBOUND FRONT FORK  
 310MM DNM® ADJUSTABLE COMPRESSION/  
 REBOUND SHOCK ABSORBER  
 TIRES FRONT & REAR 100/90-12 & 120/80/12  
 YCF® ALUMINIUM WHEEL 2.15/12 FRONT & 2.75/12 REAR  
 160MM TRIPLE CLAMP  
 CARBURETOR NIBBI® PE28

### POINTS FORTS & NOUVEAUTÉS 2026

**CADRE ET BOUCLE ARRIÈRE ALUMINIUM**  
**BRAS OSCILLANT ALUMINIUM**  
**DISQUE FREIN AVANT FLOTTANT 220MM**  
**ÉTRIER FREIN AVANT RADIAL 4 PISTONS**  
**CARÉNAGE ABS**  
**COMMANDES REÇULÉES RÉGLABLES**  
**GUIDON BRACELET RÉGLABLE**  
**DIABOLOS DE BÉQUILLE AVANT & ARRIÈRE**  
**TENDEURS DE CHAÎNE MINI GP**  
**BOUCHON RÉSERVOIR ALUMINIUM FERMETURE RAPIDE**  
**ÉCHAPPEMENT BAS**  
**SABOT RÉCUPÉRATEUR D'HUILE ÉTANCHE**  
**LIVRÉE AVEC UNE BÉQUILLE DE STAND ARRIÈRE**  
**NOUVELLE BOÎTE À AIR**  
**NOUVEAU KICK**

### HIGHLIGHTS & 2026 NEW FEATURES

ALUMINIUM FRAME AND SUBFRAME  
 ALUMINIUM SWING ARM  
 220MM FLOATING FRONT DISC  
 RADIAL 4-PISTON FRONT BRAKE CALIPER  
 ABS FAIRING  
 FULLY ADJUSTABLE REARSETS  
 FULLY ADJUSTABLE HANDLEBAR  
 FRONT & REAR SPOOL  
 MINI GP BLOCK AXLE  
 QUICK RELEASE GAS CAP  
 BELLY EXHAUST SYSTEM  
 BELLY PAN  
 INCLUDE REAR STAND  
 NEW AIR BOX  
 NEW KICKSTART



# GP187 DAYTONA®



720mm/ 28 in.

 77,3Kg/ 170 lbs

L : 680mm/ W: 27 in.

1170mm/ 46 in.

1665mm/ 65 in.



**GP PLASTIQUES**  
**YCF PLASTICS**



**CARÉNAGE DROIT**  
 RIGHT SIDE FAIRING

N° YC110-1432-02-BKM  
 N° YC110-1432-02-WH

€ 39  
 € 39



**PROTECTION AVANT**  
 FRONT GUARD

N° YC110-1445-BKM

€ 39



**CARÉNAGE GAUCHE**  
 LEFT SIDE FAIRING

N° YC110-1433-02-BKM  
 N° YC110-1433-02-WH

€ 39  
 € 39



**GARDE BOUE AVANT**  
 FRONT FENDER

N° YC110-0302-01-BKM  
 N° YC110-0302-01-WH

€ 39  
 € 39



**CARÉNAGE AVANT**  
 FRONT FAIRING

01 N° YC110-0212-13-BKM  
 01 N° YC110-0212-13-WH  
 02 N° YC110-0941(VIS PLASTIQUE/ PLASTIC SCREW)

€ 49  
 € 49  
 € 6



**COUVRE RÉSERVOIR**  
 GAS TANK COVER

N° YC110-1402-06-BKM  
 N° YC110-1402-06-WH

€ 59  
 € 65



**GARDE BOUE ARRIÈRE**  
 REAR FENDER

N° YC110-0460-02-BKM

€ 29

# GP PIÈCES MOTEUR GP ENGINE PARTS



**COQUE ARRIÈRE NOIRE, BLANCHE, ORANGE, JAUNE, VERTE**  
REAR SEAT BLACK, WHITE, ORANGE, YELLOW, GREEN

N° YC110-1402-07-BKM  
N° YC110-1402-07-WH  
N° YC110-1402-07-OR  
N° YC110-1402-07-YE  
N° YC110-1402-07-GR

€ 59  
€ 59  
€ 59  
€ 59  
€ 59



**SUPPORT DE CARÈNAGE**  
FAIRING SUPPORT

N° YC110-1444-BKM

€ 69



**SUPPORT TÊTE DE FOURCHE**  
STEEL FRONT FAIRING SUPPORT MATT BLACK

N° YC110-0738-BKM

€ 59



**SELLE 22,3mm**  
SEAT PAD FOAM MATTE BLACK 22,3mm

N° YC110-1401-2001-BKM

€ 15



**PASSAGE DE ROUE**  
REAR UNDERTAIL

N° YC110-1402-08-BKM

€ 29



**SABOT MOTEUR**  
BELLY PAN

N° YC110-0905-04-BKM

€ 49



**BOÎTE DE VIS GP**  
GP BOLT SCREW KIT

N° KVP-7

€ 59

# PIÈCES GP GP PARTS



**TUBE DE GUIDON**  
CLIP-ON BAR

01 N° YC110-0101-2501-BKM €19  
02 N° YC110-0153-02-BKM (EMBOÛT DE GUIDON) €9



**POIGNÉES CAOUTCHOUC GP**  
GP RUBBER GRIPS

N° PPC012-BK €12



**COUPE CIRCUIT AIMANTÉ**  
MAGNET KILL SWITCH

01 N° YC110-0105-07 (GP187) €29  
02 N° YC110-0105-08 (GP107/ GP124/ GP157) €29

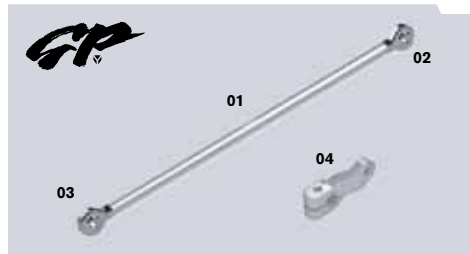

**TIGE DE SELECTEUR COMPLET**  
COMPLETE SHIFT LINKAGE

01 N° YC110-0931-ZH-SI €25  
02 N° YC110-0939-01 €12  
03 N° YC110-0939-02 €12  
04 N° YC110-0932-SI €19



**PÉDALE DE FREIN ALUMINIUM**  
ALUMINUM BRAKE PEDAL

N° YC110-0938-SI €49



**JEU DE FOURCHE NON RÉGLABLE L=650mm  
POUR GP107 ET RÉGLABLE COMPRESSION/DÉTENTE  
L=650mm POUR GP157/ GP187**

PAIR OF FORK L: 650MM NOT ADJUSTABLE TITANIUM FOR GP107 & FORK L: 650MM ADJUSTABLE COMPRESSION / REBOUND TITANIUM FOR GP157 / GP187

01 N° YC110-0400-45-TI (GP107/GP124) €399  
02 N° YC110-0400-44-TI (GP157-GP187) €599

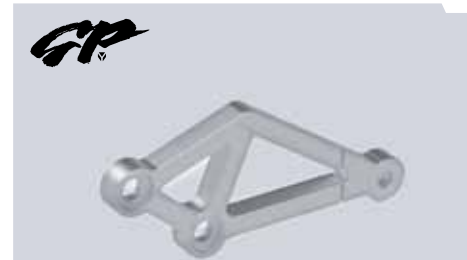

**PLATINE ALUMINIUM DE REPOSE PIED GAUCHE**  
LEFT ALUMINUM FOOTPEG SUPPORT

N° YC110-0933-SI €39



**PÉDALE DE SÉLECTEUR ALUMINIUM**  
ALUMINUM GEARSHIFT PEDAL

N° YC110-0934-SI €49

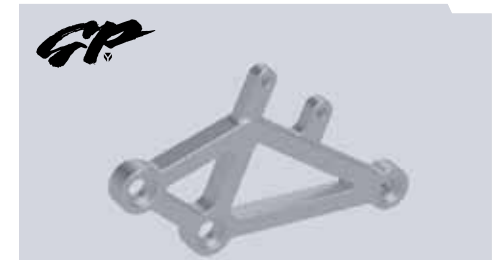

**PLATINE ALUMINIUM DE REPOSE PIED DROIT**  
RIGHT ALUMINUM FOOTPEG SUPPORT

N° YC110-0935-SI €49



**AMORTISSEUR**  
SHOCK ABSORBER

01 N° YC110-0404-17 GP107/ GP124 2024-26 €139  
02 N° YC110-0404-98 GP124 2025-26/ GP157 2024 €199  
03 N° YC110-0404-35 GP157 2025-26/ GP187 2024-26 €339



**BOUCHON RÉSERVOIR RAPIDE COMPLET**  
ALUMINUM QUICK RELEASE GAS CAP

N° YC110-0721 €89





**FILTRE À AIR**  
AIR FILTER

N° KL-ZT-HP-55

€ 29



**GUIDE CHAÎNE**  
CHAIN GUIDE ASSEMBLY

01 N° YC110-1004-01 (2024)  
02 N° YC110-1005 (2025-26)

€ 35  
€ 29



**EMBOUIT TÉFLON DE REPOSE PIED**  
MINI GP FOOT PEG SLIDER

N° YC110-1037-BK

€ 9



**ÉCHAPEMENT COMPLET**  
COMPLETE MINIGP SINGLE RACING MUFFLER  
& EXHAUST

N° YC110-139-15 (GP 107/GP 124)  
N° YC110-139-14 (GP 157)  
N° YC110-139-13 (GP 187)

€ 219  
€ 219  
€ 219



**RÉSERVOIR**  
GAS TANK

N° YC110-0701-08

€ 69



**JEUX DE TENDEURS DE CHAÎNE**  
AXLE BLOCK ADJUSTER

N° YC110-1021-MG

€ 39



**DIABOLO TEFLON**  
SPOOL TEFLON MATT BLACK

N° YC110-1035-02-BK

€ 13



**REPOSES PIEDS ALUMINIUM**  
ALUMINUM FOOTPEGS KIT

N° YC110-0902-18-SI

€ 49



**EMBOUIT DE TÉFLON DE SÉLECTEUR/ PÉDALE DE FREIN**  
POM GEARSHIFT END CAP/ BRAKE FOOTPEG

N° YC110-0903-11

€ 15

# PIÈCES RACING GP GP RACING PARTS

GP



**BÉQUILLE AVANT/ ARRIÈRE**  
FRONT/ REAR STAND

N° STAND1MOTO-04

€ 59



GP



**KIT FREIN AVANT RADIAL 2 PISTONS L: 775mm**  
RADIAL FRONT BRAKE ASSY 2 PUMPS L: 775mm

01 N° YC110-0512-10  
02 N° YC110-0506-01

€ 169  
€ 17

GP



**KIT FREIN ARRIÈRE D10/10 L: 365mm**  
REAR BRAKE ASSY D10/10 L: 365mm

01 N° YC110-1212-10  
02 N° YC110-1204-02

€ 99  
€ 17

GP



**PAIRE DE COUVERTURE CHAUFFANTE AVEC BOITIER DE RÉGLAGE INDEPENDANT JUSQU'À 99 DEGRES**  
TIRE WARMERS WITH INDEPENDANT ADJUSTABLE TEMPERATURE CONTROL (UP TO 99 DEGREES)

N° YC110-1125-01-BK

€ 269

GP



**FREIN ARRIÈRE AU GUIDON GP**  
REAR BRAKE HANDLE BAR GP

N° YC110-12012-34

€ 89

GP



**KIT FREIN ARRIÈRE AU POUCE**  
THUMB BRAKE

N° YC110-1212-13

€ 99



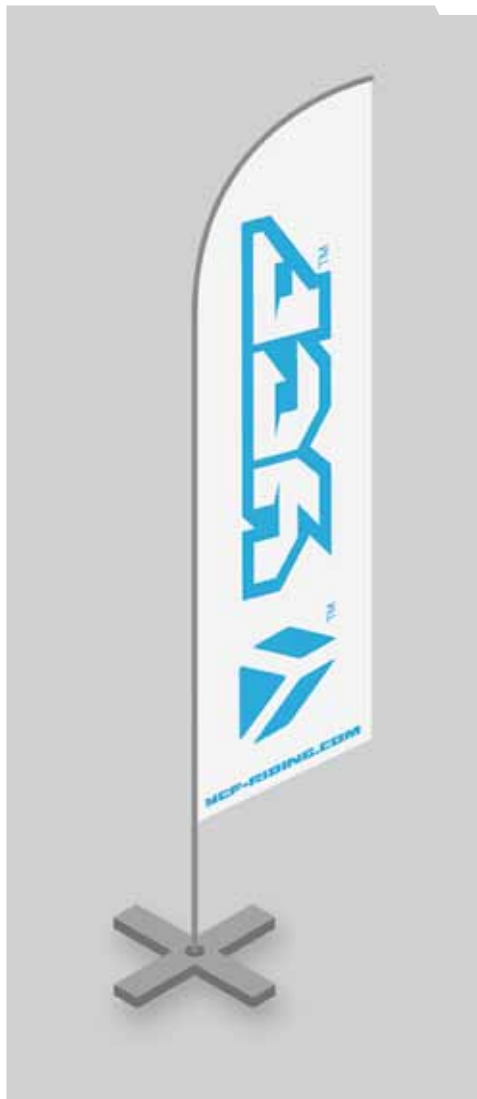

**ORIFLAMME**  
FLAG

N° YCF-FLAG-3M (3 METERS-118 in.)

€ 99

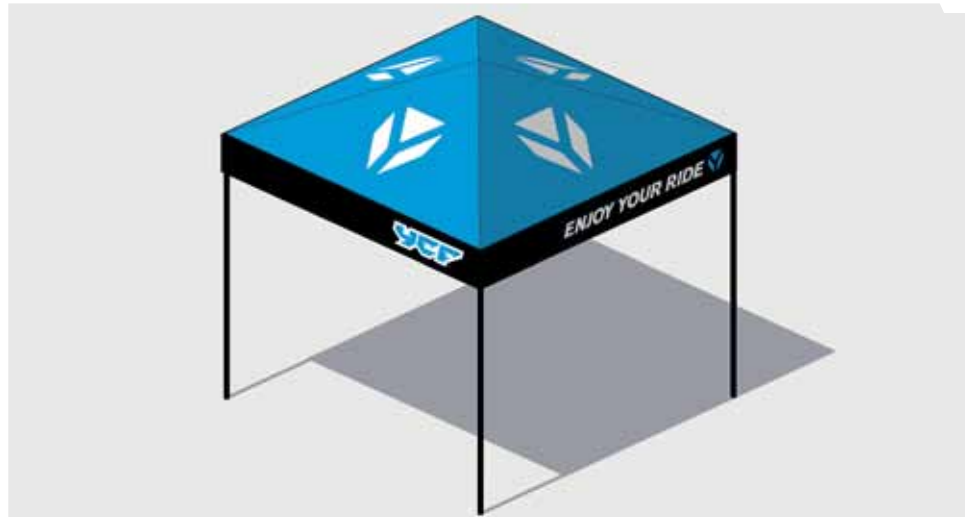

**TONNELLE 3 X 3M YCF (100% ÉTANCHE) VELCRO INTÉGRAL AUTOUR DU TOIT**  
YCF PIT TENT 3 X 3M (100% WATERPROOF) INTEGRAL VELCRO AROUND THE ROOF

N° TONNELLEYCF-4

€ 149



**RUBALISE DE TERRAIN (ROULEAU DE 100 MÈTRES)**  
BANNER ROLL (100 METERS ROLL)

N° RUB-1

€ 15



**BANDEROLE DE TERRAIN EN FEUTRINE 1 X 25M**  
BANNER ROLL 1 X 25M

N° FEUTRINE-1

€ 99



**BANNER YCF 2 X 0,50M**  
YCF BANNER 2 X 0,50M

N° BANNER-01

€ 29



**BÂCHE MOTO**  
MOTORCYCLE COVER

N° BIKECOVER-BL

€ 29

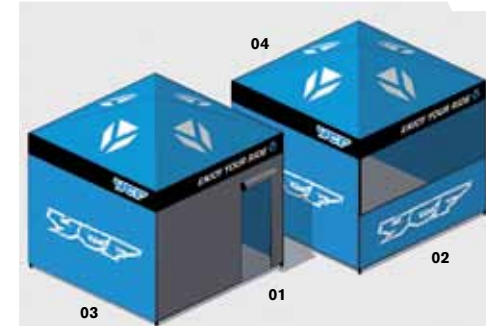

**CÔTÉ DE TONNELLE 3 X 3M AVEC PORTE ZIPPÉE**  
PIT TENT SIDE 3 X 3M WITH ZIP DOOR

01 N° PORTE-1

€ 59

**DEMI CÔTÉ DE TONNELLE**  
PIT TENT HALF SIDE

02 N° DEMICOTE-1-BL

€ 39

**CÔTÉ DE TONNELLE 3 X 3M**  
PIT TENT SIDE 3 X 3M

03 N° COTE-1-BL

€ 49

**TOIT DE TONNELLE 3 X 3M**  
PIT TENT ROOF 3 X 3M

04 N° ROOF3X3YCF-BL

€ 59



**CHAISE PLIABLE YCF**  
YCF FOLDING CHAIR

N° CHAIR01-BK

€ 49



**TRÉPIED ALUMINIUM NOIR/ BLEU/ VERT/ ORANGE/ ROUGE - HAUTEUR 40 cm**  
ALUMINUM BIKE STAND BLACK/ BLUE/ GREEN/ ORANGE/ RED - HEIGHT 15,7 in.

N° TREPIED-COLOR

€ 109



**BÉQUILLE ROUE AV AR RÉGLABLE AVEC ROULETTES**  
FRONT/ REAR STAND. COMES WITH HEIGHT ADJUSTABLE FORKS FOR SPOOLS

N° STAND1MOTO-04

€ 59



**TAPIS SOL ENVIRONNEMENTAL YCF 180X80 CM**  
ENVIRONMENTAL YCF RUBBER MAT 180X80 CM (70in x 31 in.)

N° TAPISSOL-4

€ 79



**TRÉPIED ACIER NOIR pour 50/88 - HAUTEUR 32 cm**  
50/88 STEEL BIKE STAND BLACK - HEIGHT 12 in.

N° TREPIED02-BK

€ 69



**TRÉPIED ACIER NOIR - HAUTEUR 40 cm**  
STEEL BIKE STAND BLACK - HEIGHT 15,7 in.

N° TREPIED01-BK

€ 69



**BÉQUILLE ROUE AR RÉGLABLE**  
ADJUSTABLE REAR WHEEL STAND

N° STAND1MOTO-02

€ 39

**TEXTILES  
APPAREL**



**PARAPLUIE YCF**  
YCF UMBRELLA

N° UMBRELLA

€ 29



**BONNET YCF**  
YCF BEANIE

N° BYCF01-BK

€ 15



**BOB YCF**  
YCF BUCKET HAT

N° BOB-BK

€ 19



**CHAPEAU YCF**  
YCF STRAW HAT

N° STHYCF

€ 29



**POLO RACING YCF (S/ M/ L/ XL/ XXL)**  
YCF SHORT SLEEVE POLO (S/ M/ L/ XL/ XXL)

N° POLOYCF01BL+TAILLE/SIZE

€ 29



**T-SHIRT ENFANT YCF (TAILLE: 4 ANS/ 8 ANS)**  
YCF YOUTH T-SHIRT (SIZE: 4 YEARS/ 8 YEARS)

N° TSK02BL-4 (4 YEARS)  
N° TSK02BL-8 (8 YEARS)

€ 19



**SAC À DOS YCF**  
YCF BACKPACK

N° BACKPACKYCF-GY

€ 49



**SAC DE TRANSPORT 54X32X32cm**  
DUFFLE BAG 54X32X32cm

N° BAGYCF-BL

€ 39



**NEW  
2026**

**SWEAT À CAPUCHE YCF (TAILLE : S/ M/ L/ XL/ XXL)**  
YCF HOODIE (SIZE: S/ M/ L/ XL/ XXL)

N° SWEAT05BL+TAILLE/SIZE € 59



**NEW  
2026**

**T-SHIRT YCF GP (TAILLE : S/ M/ L/ XL/ XXL)**  
YCF GP T-SHIRT (SIZE: S/ M/ L/ XL/ XXL)

N° TSYCFPU+TAILLE/SIZE (HOMME/ MEN) € 19  
N° TSGFPPU+TAILLE/SIZE (FEMME/ WOMEN)



**NEW  
2026**

**CASQUETTE YCF À VISIÈRE COURBÉE**  
YCF CURVED BILL HAT

N° CYCF06-GY € 19



**NEW  
2026**

**CASQUETTE BASEBALL YCF**  
YCF SNAPBACK HAT

N° CYCF06-PU € 19



**NEW  
2026**

**T-SHIRT YCF (TAILLE : S/ M/ L/ XL/ XXL)**  
YCF T-SHIRT (SIZE: S/ M/ L/ XL/ XXL)

N° TSYCFGY03+TAILLE/SIZE (HOMME/ MEN) € 19  
N° TSFYCFGY03+TAILLE/SIZE (FEMME/ WOMEN)



**NEW  
2026**

**CASQUETTE YCF COULEUR**  
YCF COLORED HAT

N° CYCF06+COLOR € 19



**NEW  
2026**

**T-SHIRT YCF (TAILLE : S/ M/ L/ XL/ XXL)**  
YCF T-SHIRT (SIZE: S/ M/ L/ XL/ XXL)

N° TSYCFGR03+TAILLE/SIZE (HOMME/ MEN) € 19  
N° TSYCFWH03+TAILLE/SIZE (HOMME/ MEN)  
N° TSYCFYE03+TAILLE/SIZE (HOMME/ MEN)  
N° TSYCFBL03+TAILLE/SIZE (HOMME/ MEN)  
N° TSYCFRD03+TAILLE/SIZE (HOMME/ MEN)  
N° TSFYCFGR02+TAILLE/SIZE (FEMME/ WOMEN)  
N° TSFYCFWH02+TAILLE/SIZE (FEMME/ WOMEN)  
N° TSFYCFYE02+TAILLE/SIZE (FEMME/ WOMEN)  
N° TSFYCFBL02+TAILLE/SIZE (FEMME/ WOMEN)  
N° TSFYCFRD02+TAILLE/SIZE (FEMME/ WOMEN)

# GRAPHICS & PLASTICS

## ACCESSOIRES PLASTIQUES

KITS DÉCO/ GRAPHIC KITS 70  
KITS PLASTIQUES/ PLASTIC KITS 76



**RACING**  
KITS DÉCO/  
GRAPHIC KITS 3M



**KIT DÉCO DE CADRE POUR FACTORY**  
GRAPHIC KIT FOR FACTORY FRAME

N° FGKFP-BK

€ 15



**KIT DÉCO DE CADRE POUR PILOT**  
GRAPHIC KIT FOR PILOT FRAME

N° FGKP-BK

€ 15

**NEW  
2026**



# ORIGINAL YCF® KITS DÉCO/ GRAPHIC KITS



**KIT DÉCO 50AE YCF 2026**  
50AE YCF GRAPHIC KIT 2026

N° KD50AE2026 (50 SEULEMENT/ ONLY) € 59



**KIT DÉCO 50E YCF 2026**  
50E YCF GRAPHIC KIT 2026

N° KD50E2026 (50 SEULEMENT/ ONLY) € 59



**KIT DÉCO LITE 88 2026**  
GRAPHIC KIT LITE 88 2026

N° KD88L2026 € 59



**KIT DÉCO LITE 125 2026**  
GRAPHIC KIT LITE 125 2026

N° KD125L2026 € 59



**KIT DÉCO LITE 150 2026**  
GRAPHIC KIT LITE 120 2026

N° KD150L2026 € 59



**KIT DÉCO LITE 150L 2026**  
GRAPHIC KIT LITE 120 2026

N° KDL150L2026 € 59



**KIT DÉCO START W88E 2026**  
GRAPHIC KIT START W88E 2026

N° KD88E2026 € 59



**KIT DÉCO START 88SE 2026**  
GRAPHIC KIT START 88SE 2026

N° KD88SE2026 € 59





**KIT DÉCO START 125SE 2026**  
GRAPHIC KIT START 125SE 2026

N° KD125SE2026

€ 59



**KIT DÉCO PILOT 150 2026**  
GRAPHIC KIT PILOT 150 2026

N° KDP1502026

€ 69



**KIT DÉCO FACTORY SP2 2026**  
GRAPHIC KIT FACTORY SP2 2026

N° KDSP22026

€ 69



**KIT DÉCO FACTORY SP3 190 2026**  
GRAPHIC KIT FACTORY SP3 190 2026

N° KDSP31902026

€ 69



**KIT DÉCO SM 125 2026**  
GRAPHIC KIT SM 125 2026

N° KD SM1252026

€ 59



**KIT DÉCO SM 155 2026**  
GRAPHIC KIT SM 155 2026

N° KD SM1552026

€ 69



**KIT DÉCO SM 190 2026**  
GRAPHIC KIT SM 190 2026

N° KD SM1902026

€ 69

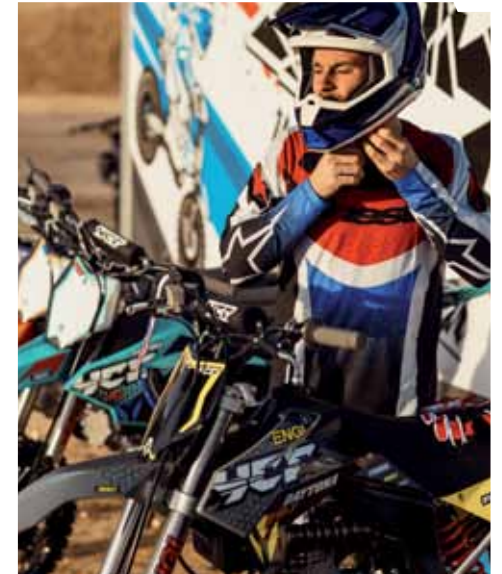

**NEW  
2026**



**ORIGINAL YCF®  
KITS DÉCO/ GRAPHIC KITS**



**KIT DÉCO BIGY 150 2026**  
GRAPHIC KIT BIGY 150 2026

N° KDBIGY1502026 € 79



**KIT DÉCO BIGY FACTORY 150 2026**  
GRAPHIC KIT BIGY FACTORY 150 2026

N° KDBIGYF15026 € 79



**KIT DÉCO BIGY FACTORY 190 MX DAYTONA® XL 2026**  
GRAPHIC KIT BIGY FACTORY 190 MX DAYTONA® XL 2026

N° KDBIGYFD190XL26 € 79



**PLANCHE DE STICKERS**  
STICKERS SHEET

N° STSYVCF-01 € 6



NEW  
2026



**KIT DÉCO 50AE LIMITÉ**  
GRAPHIC KIT 50AE LIMITED

N° KD-25-50AE-LTDWH

€ 59



NEW  
2026



**KIT DÉCO START 88SE LIMITÉ**  
GRAPHIC KIT START 88SE LIMITED

N° KD-25-START-88SE-LTDRD

€ 59



NEW  
2026



**KIT DÉCO START 125S LIMITÉ**  
GRAPHIC KIT START 125S LIMITED

N° KD-25-START-125S-LTDBL

€ 59



NEW  
2026



**KIT DÉCO PILOT 150 LIMITÉ**  
GRAPHIC KIT PILOT 150 LIMITED

N° KD-25-PILOT-150-LTDGR

€ 69



NEW  
2026



**KIT DÉCO BIGY 150 LIMITÉ**  
GRAPHIC KIT BIGY 150 LIMITED

N° KD-25-BIGY-150-LTDYE

€ 79





# KITS PLASTIQUES YCF

## YCF PLASTIC KITS



**PLAQUE AVANT POUR LITE/ START/ PILOT/ FACTORY/ SM/ NOIRE/ BLEUE/ ROUGE/ VERTE/ JAUNE/ ORANGE/ ROSE/ BLANCHE/ GRISE**

FRONT NUMBER PLATE FOR LITE/ START/ PILOT/ FACTORY/ SM/ BLACK/ BLUE/ RED/ GREEN/ YELLOW/ ORANGE/ PINK/ WHITE/ GREY

N° YC110-0212-07+COLOR

€ 15



**GARDE BOUE AVANT POUR LITE 125/ LITE 150/ START 125/ PILOT/ FACTORY/ START 88SE 2021 NOIR/ BLEU/ ROUGE/ VERT/ JAUNE/ ORANGE/ ROSE/ BLANC/ GRIS**

FRONT FENDER FOR LITE 125/ LITE 150/ START 125/ PILOT/ FACTORY/ START 88SE 2021 BLACK/ BLUE/ RED/ GREEN/ YELLOW/ ORANGE/ PINK/ WHITE/ GREY

N° YC110-032-02+COLOR

€ 15



**OUIE RADIATEUR DROITE EN 2 PARTIES POUR LITE/ START 2020-26/ PILOT 2018-26/ FACTORY 2017-26/ SM 2014-26/ NOIRE/ BLEUE/ ROUGE/ VERTE/ JAUNE/ ORANGE/ BLANCHE/ GRISE/ ROSE**

RIGHT SHROUD 2 PARTS FOR LITE/ START 2020-26/ PILOT 2018-26/ FACTORY 2017-26/ SM 2014-26/ BLACK/ BLUE/ RED/ GREEN/ YELLOW/ ORANGE/ WHITE/ GREY/ PINK

N° YC110-14-059-COLOR

€ 19



**OUIE RADIATEUR GAUCHE EN 2 PARTIES POUR LITE/ START 2020-26/ PILOT 2018-26/ FACTORY 2017-26/ SM 2014-26/ NOIRE/ BLEUE/ ROUGE/ VERTE/ JAUNE/ ORANGE/ BLANCHE/ GRISE/ ROSE**

LEFT SHROUD 2 PARTS FOR LITE/ START 2020-26/ PILOT 2018-26/ FACTORY 2017-26/ SM 2014-26/ BLACK/ BLUE/ RED/ GREEN/ YELLOW/ ORANGE/ WHITE/ GREY/ PINK

N° YC110-14-069-COLOR

€ 19



**PLAQUE LATÉRALE DROITE POUR LITE 88-125/ START 2017-26/ PILOT 2007-15/ FACTORY 2007-15  
SM 125 2014-26 NOIRE/ BLEUE/ ROUGE/ VERTE/ JAUNE/ ORANGE/ ROSE/ BLANCHE/ GRISE**  
RIGHT NUMBER PLATE FOR LITE 88-125/ START 2017-26/ PILOT 2007-15/ FACTORY 2007-15  
SM 125 2014-26 BLACK/ BLUE/ RED/ GREEN/ YELLOW/ ORANGE/ PINK/ WHITE/ GREY

Nº YC110-14-022+COLOR

€ 12



**PLAQUE LATÉRALE GAUCHE POUR LITE 88-125/ START 2017-26/ PILOT 2007-15/ FACTORY 2007-15  
SM 125 2014-26 NOIRE/ BLEUE/ ROUGE/ VERTE/ JAUNE/ ORANGE/ ROSE/ BLANCHE/ GRISE**  
LEFT NUMBER PLATE FOR LITE 88-125/ START 2017-26/ PILOT 2007-15/ FACTORY 2007-15  
SM 125 2014-26 BLACK/ BLUE/ RED/ GREEN/ YELLOW/ ORANGE/ PINK/ WHITE/ GREY

Nº YC110-14-042+COLOR

€ 12



**PLAQUE LATÉRALE DROITE POUR LITE 150 2026/ PILOT 2016-26/ FACTORY 2016-26  
SM 155/ SM 190 2016-26 NOIRE/ BLEUE/ ROUGE/ VERTE/ JAUNE/ ORANGE/ BLANCHE/ GRISE/ ROSE**  
RIGHT NUMBER PLATE FOR LITE 150 2026/ PILOT 2016-26/ FACTORY 2016-26  
SM 155/ SM 190 2016-26 BLACK/ BLUE/ RED/ GREEN/ YELLOW/ ORANGE/ WHITE/ GREY/ PINK

Nº YC110-14-028+COLOR

€ 15



**PLAQUE LATÉRALE GAUCHE POUR LITE 150 2026/ PILOT 2016-26/ FACTORY 2016-26  
SM 155/ SM 190 2016-26 NOIRE/ BLEUE/ ROUGE/ VERTE/ JAUNE/ ORANGE/ BLANCHE/ GRISE/ ROSE**  
LEFT NUMBER PLATE FOR LITE 150 2026/ PILOT 2016-26/ FACTORY 2016-26  
SM 155/ SM 190 2016-26 BLACK/ BLUE/ RED/ GREEN/ YELLOW/ ORANGE/ WHITE/ GREY/ PINK

Nº YC110-14-048+COLOR

€ 15



**GARDE BOUE ARRIÈRE POUR LITE 88-125/ START 2007-26/ PILOT 2007-15/ FACTORY 2007-15  
SM 2014-26 NOIR/ BLEU/ ROUGE/ VERT/ JAUNE/ ORANGE/ ROSE/ BLANC/ GRIS**

REAR FENDER FOR LITE 88-125/ START 2007-26/ PILOT 2007-15/ FACTORY 2007-15  
SM 2014-26 BLACK/ BLUE/ RED/ GREEN/ YELLOW/ ORANGE/ PINK/ WHITE/ GREY

N° YC110-14-012+COLOR

€ 12



**PAIRE DE PROTECTIONS FOURCHE (ADAPTABLE SUR TOUTES LES FOURCHES)  
NOIRES/ BLEUES/ ROUGES/ VERTES/ JAUNES/ ORANGES/ BLANCHES/ ROSE**

PAIR OF FORK GUARD (WITH SLOTTED HOLE ADAPTABLE TO ALL FORKS)  
BLACK/ BLUE/ RED/ GREEN/ YELLOW/ ORANGE/ WHITE/ PINK

N° PFYCF12-COLOR (735mm)  
N° YC110-0418-01WH (BLANC/ WHITE - 660mm)  
N° YC110-0418-01BK (NOIR/ BLACK - 660mm)

€ 25  
€ 30  
€ 30



**GARDE BOUE ARRIÈRE POUR LITE 150 2026/ PILOT 2016-26/ FACTORY 2016-26  
SM 155/ SM190 2016-26 NOIR/ BLEU/ ROUGE/ VERT/ JAUNE/ ORANGE/ BLANC/ GRIS/ ROSE**

REAR FENDER FOR LITE 150 2026/ PILOT 2016-26/ FACTORY 2016-26  
SM 155/ SM 190 2016-26 BLACK/ BLUE/ RED/ GREEN/ YELLOW/ ORANGE/ WHITE/ GREY/ PINK

N° YC110-14-018+COLOR

€ 15



**FOR 50 ONLY**



**PAIRE DE PROTECTIONS FOURCHE POUR YCF 50 ROUGE/ VERT/ JAUNE/ ORANGE/ BLANC**  
FORK GUARD FOR YCF 50 RED/ GREEN/ YELLOW/ ORANGE/ WHITE

N° YC50-0418-02-COLOR

€ 15



**NEW  
2026**



**GARDE BOUE AVANT YCF LITE 150L 2026/ BIGY/ NOIR/ BLEU/ BLEU YCF/ ROUGE/ VERT/ JAUNE/ ORANGE/ BLANC/ GRIS/ ROSE/ TURQUOISE**  
YCF FRONT FENDER LITE 150L 2026/ BIGY/ BLACK/ BLUE/ YCF BLUE/ RED/ GREEN/ YELLOW/ ORANGE/ WHITE/ GREY/ PINK/ TURQUOISE

N° YC110-032-10-COLOR

€ 19



**NEW  
2026**



**GARDE BOUE ARRIÈRE YCF NOIR/ ROUGE/ BLANC/ VERT/ JAUNE/ ORANGE/ BLEU/ GRIS/ ROSE/ TURQUOISE**  
YCF REAR FENDER BLACK/ RED/ WHITE/ GREEN/ YELLOW/ ORANGE/ BLUE/ GREY/ PINK/ TURQUOISE

N° YC110-14-019-COLOR

€ 19



**NEW  
2026**



**OUIE RADIATEUR YCF DROITE NOIRE/ BLEUE/ ROUGE/ VERTE/ JAUNE/ ORANGE/ BLANCHE/ GRISE/ ROSE/ TURQUOISE**  
YCF RIGHT SHROUD BLACK/ BLUE/ RED/ GREEN/ YELLOW/ ORANGE/ WHITE/ GREY/ PINK/ TURQUOISE

N° YC110-1406-COLOR

€ 19



**NEW  
2026**



**OUIE RADIATEUR YCF GAUCHE NOIRE/ BLEUE/ ROUGE/ VERTE/ JAUNE/ ORANGE/ BLANCHE/ GRISE/ ROSE/ TURQUOISE**  
YCF LEFT SHROUD BLACK/ BLUE/ RED/ GREEN/ YELLOW/ ORANGE/ WHITE/ GREY/ PINK/ TURQUOISE

N° YC110-1407-COLOR

€ 19



**PLAQUE AVANT YCF NOIR/ BLEU/ BLEU YCF/ ROUGE/ VERT/ JAUNE/ ORANGE/ BLANC/ GRIS**  
YCF FRONT NUMBER PLATE BLACK/ BLUE/ YCF BLUE/ RED/ GREEN/ YELLOW/ ORANGE/ WHITE/ GREY

N° YC110-0212-09-COLOR

€ 19



**PLAQUE LATÉRALE YCF DROITE NOIR/ BLEU/ ROUGE/ VERT/ JAUNE/ ORANGE/ BLANC/ GRIS**  
YCF RIGHT NUMBER PLATE BLACK/ BLUE/ RED/ GREEN/ YELLOW/ ORANGE/ WHITE/ GREY

N° YC110-14-029-COLOR

€ 19



**PLAQUE LATÉRALE YCF GAUCHE NOIR/ BLEU/ ROUGE/ VERT/ JAUNE/ ORANGE/ BLANC/ GRIS**  
YCF LEFT NUMBER PLATE BLACK/ BLUE/ RED/ GREEN/ YELLOW/ ORANGE/ WHITE/ GREY

N° YC110-14-049-COLOR

€ 19



FOR 50 ONLY



**KIT PLASTIQUE YCF 50 NOIR/ BLEU/ ROUGE/ VERT/ JAUNE/ ORANGE/ ROSE/ BLANC/ GRIS**

YCF 50 PLASTIC KIT BLACK/ BLUE/ RED/ GREEN/ YELLOW/ ORANGE/ PINK/ WHITE/ GREY

N° KPYCF50-02-COLOR

€ 69

**GARDE BOUE AVANT POUR YCF 50, LITE 88 2020-26, START 88SE 2022-26, SM 2022-26 NOIR/ BLEU/ ROUGE/ VERT/ JAUNE/ ORANGE/ ROSE/ BLANC/ GRIS**

FRONT FENDER FOR YCF 50, LITE 88 2020-26, START 88SE 2022-26, SM 2022-26 BLACK/ BLUE/ RED/ GREEN/ YELLOW/ ORANGE/ PINK/ WHITE/ GREY

01 N° YC50-031-01-COLOR

€ 15



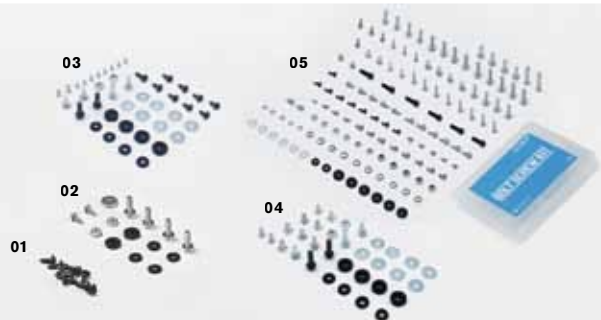

**KIT VIS POUR FIXER LES PLASTIQUES SUR LA SELLE**  
BOLT KIT FOR FIXING THE PLASTICS TO THE SEAT

01 N° KVP € 2

**KIT VISSERIE POUR KIT PLASTIQUE (2+2 POUR RÉSERVOIR + 2 POUR SELLE SUR CADRE)**  
BOLT KIT FOR PLASTIC KIT (2+2 FOR FUEL TANK + 2 FOR SEAT ON FRAME)

02 N° KVP-2 € 3

**KIT VISSERIE POUR PLASTIQUE START/ PILOT/ FACTORY**  
BOLT KIT FOR PLASTIC KIT START/ PILOT/ FACTORY

03 N° KVP-3 € 6

**KIT VISSERIE POUR PLASTIQUE BIGY**  
BOLT KIT FOR PLASTIC KIT BIGY

04 N° KVP-4 € 6

**KIT VIS COMPLET YCF AVEC BOÎTE DE RANGEMENT**  
COMPLETE YCF BOLT KIT WITH BOX

05 N° KVP-5 € 39



**PROTÈGE DISQUE AVANT NOIR/ BLEU/ ROUGE/ VERT/ JAUNE/ ORANGE/ BLANC**  
FRONT BRAKE PROTECTION BLACK/ BLUE/ RED/ GREEN/ YELLOW/ ORANGE/ WHITE

N° YC110-0627-01+COLOR € 29



**PASSE DURITE FREIN AVANT CNC NOIR/ BLEU/ ROUGE/ VERT/ ORANGE/ VIOLET**  
ALUMINUM BRAKE LINE RETAINER BLACK/ BLUE/ RED/ GREEN/ ORANGE/ PURPLE

N° YC110-0403-06+COLOR € 19



**PASSE DURITE YCF**  
YCF BRAKE LINE RETAINER-PLASTIC

01 N° YC110-0403-05 € 5



**KIT RONDELLE CNC POUR RÉSERVOIR ET KIT PLASTIQUE, VENDU AVEC LES VIS BTR (2XM5/ 2XM6/ 1XM8)**  
NOIR/ BLEU/ ROUGE/ VERT/ ORANGE/ VIOLET  
CNC WASHER AND BTR SCREW FOR TANK AND PLASTIC KIT (2XM5/ 2XM6/ 1XM8)  
BLACK/ BLUE/ RED/ GREEN/ ORANGE/ PURPLE

N° KRV-COLOR € 19



**KIT COMPLET PHARES POUR START/ LITE/ FACTORY SP1 & SP2/ BIGY 125 & 150**  
LIGHT KIT FOR START/ LITE/ FACTORY SP1 & SP2/ BIGY 125 & 150

N° KL1E pour moto avec démarreur électrique/ for electric start bike € 119  
N° KL1 pour moto sans démarreur électrique/ for bike without electric start € 159  
01 N° YC110-1525-02 Bavette arrière/ tail light mud guard € 29



**PLAQUE PHARE AVANT YCF NOIRE/ BLANCHE**  
YCF HEADLIGHT BLACK/ WHITE

N° YC110-1523-02 - COLOR € 59

# MOTORCYCLE PARTS

## PIÈCES MOTO

<b>GUIDONS/ HANDLEBARS</b>	84
<b>POIGNÉES/ LEVERS</b>	86
<b>FOURCHES/ FORKS</b>	88
<b>CADRES/ FRAMES</b>	91
<b>SELLES/ SEATS</b>	92
<b>RÉSERVOIRS/ FUEL TANKS</b>	93
<b>FREINS/ BRAKES</b>	94
<b>BRAS OSCILLANTS/ SWING ARMS</b>	102
<b>AMORTISSEURS/ SHOCK ABSORBERS</b>	104
<b>ROUES/ WHEELS</b>	105
<b>JANTES &amp; MOYEUX/ RIMS &amp; HUBS</b>	105
<b>PNEUS/ TIRES</b>	112
<b>REPOSE-PIEDS &amp; SABOTS/ FOOT PEGS &amp; SKID PLATES</b>	114
<b>SÉLECTEURS/ SHIFT LEVERS</b>	115
<b>KITS CHÂINES/ SPROCKET KITS</b>	116
<b>OUTILS/ TOOLS</b>	118
<b>ENGI®/ ENGI®</b>	120



# GUIDONS HANDLE BARS



**MOUSSE GUIDON SANS BARRE**  
NOIRE/ BLEUE/ ROUGE/ VERTE/ JAUNE/ ORANGE/ ROSE/ BLANCHE  
HANDLEBAR PAD WITHOUT CROSSBAR  
BLACK/ BLUE/ RED/ GREEN/ YELLOW/ ORANGE/ PINK/ WHITE

N° YC110-01046+COLOR

€ 12



**MOUSSE GUIDON CAOUTCHOUC 3D**  
HANDLEBAR PAD WITH RUBBER COVER 3D

N° YC110-0133-01BK

€ 12



FOR 50 ONLY

**MOUSSE GUIDON YCF 50 SANS BARRE**  
NOIRE/ BLEUE/ ROUGE/ VERTE/ JAUNE/ ORANGE/ ROSE/ BLANCHE  
HANDLEBAR PAD YCF 50 WITHOUT CROSSBAR  
BLACK/ BLUE/ RED/ GREEN/ YELLOW/ ORANGE/ PINK/ WHITE

N° YC50-0129+COLOR

€ 8



**MOUSSE GUIDON NOIRE/ BLEUE/ ROUGE/ VERTE/ JAUNE/ ORANGE/ ROSE/ BLANCHE**  
HANDLEBAR PAD BLACK/ BLUE/ RED/ GREEN/ YELLOW/ ORANGE/ PINK/ WHITE

N° YC110-0132+COLOR

€ 10



**PAIRE DE PROTÈGES MAINS**  
HANDGUARD

N° YC110-14-070BK (NOIRE/ BLACK)  
N° YC110-14-070WH (BLANCHE/ WHITE)

€ 25



**PAIRE DE PROTÈGES MAINS ENDURO/SUPERMOTO**  
(FIXATION POUR GUIDON ACIER/ALU Ø 22,2 ET 28,6)  
ENDURO/SUPERMOTO HANDGUARDS  
(FIXING KITS FOR STEEL/ALU Ø 22,2 AND 28,6)

N° YC110-14-071BK (NOIRE/ BLACK)  
N° YC110-14-071WH (BLANCHE/ WHITE)

€ 69



**PROTÈGE LEVIER TYPE MOTOGP**  
MOTOGP STYLE LEVER PROTECTION

N° YC110-14-072BK

€ 39



**GUIDON ALUMINIUM (MOUSSE COMPRISE)  
NOIR/ BLEU/ ROUGE/ VERT/ ORANGE/ VIOLET**

ALUMINUM HANDLEBAR (BAR PAD INCLUDED)  
BLACK/ BLUE/ RED/ GREEN/ ORANGE/ PURPLE

N° GA+COLOR

€ 45



**GUIDON MID SIZE ALUMINIUM (MOUSSE COMPRISE)  
NOIR/ BLEU/ ROUGE/ VERT/ ORANGE/ VIOLET**

ALUMINUM CROSS BAR (BAR PAD INCLUDED)  
BLACK/ BLUE/ RED/ GREEN/ ORANGE/ PURPLE

N° GALOW+COLOR  
N° GALOW-03BK (BIGY)

€ 45

€ 49



**GUIDON ALUMINIUM SANS BARRE (POUR YCF 50) NOIR/ BLEU/ ROUGE/ VERT/  
ORANGE (MOUSSE COMPRISE)**

ALUMINUM HANDLEBAR WITHOUT CROSSBAR (FOR YCF 50) BLACK/ BLUE/ RED/ GREEN/  
ORANGE (BAR PAD INCLUDED)

01 N° GASB50+COLOR

€ 39

**GUIDON ALUMINIUM SANS BARRE BLEU/ NOIR/ ROUGE/ ORANGE/ VERT/ VIOLET  
(MOUSSE COMPRISE)**

ALUMINUM HANDLEBAR WITHOUT CROSSBAR BLUE/ BLACK/ RED/ ORANGE/ GREEN/  
PURPLE (BAR PAD INCLUDED)

02 N° GASB+COLOR

€ 59

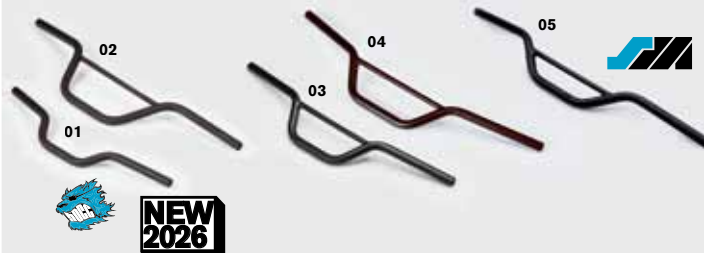

**GUIDON CHROMOLLY 22,2mm**

CHROMOLLY HANDLEBAR 22,2mm

01 N° YC50-0101-02 (YCF 50 2012-25)

€ 19

01 N° YC50-0101-03 (YCF 50 2026) (GRIP 19mm)

€ 19

02 N° YC110-0101-34-BK (LITE/ START/ PILOT)

€ 19

03 N° YC110-0101-12 (BAS/ LOW: 665mm)

€ 19

04 N° YC110-0101-1601-BK (BIGY: 780mm)

€ 19

05 N° YC110-0101-36-BK (BAS/ LOW: 760mm) SM 2024-26

€ 19



**GUIDON ALUMINIUM RENFORCÉ 28.6 mm**

ALUMINUM HANDLEBAR 28.6 mm

N° GA-02BK (FACTORY 760mm)

€ 79

N° GALOW-04BK (BIGY 780mm)

€ 79



# POIGNÉES HANDLES



FOR 50 ONLY



**FACTORY**  
SPECIAL PARTS  
YCF RACING

**LEVIER DE FREIN AVANT OU ARRIÈRE PLIABLE POUR YCF 50 2020-26  
NOIR/ BLEU/ ROUGE/ VERT/ ORANGE**

FOLDABLE FRONT OR REAR BRAKE LEVER FOR YCF 50 2020-26  
BLACK/ BLUE/ RED/ GREEN/ ORANGE

01 № LFG50-1-COLOR (ARRIÈRE/ REAR)  
02 № LFD50-1-COLOR (AVANT/ FRONT)

€ 35



**FACTORY**  
SPECIAL PARTS  
YCF RACING



**LEVIER D'EMBRAYAGE AVEC COCOTTE CNC NOIR/ BLEU/ ROUGE/ VERT  
CLUTCH LEVER WITH CNC BRACKET BLACK/ BLUE/ RED/ GREEN**

№ YC110-0103-06+COLOR

€ 99

**FACTORY**  
SPECIAL PARTS  
YCF RACING



**LEVIER DE FREIN OU D'EMBRAYAGE PLIABLE NOIR/ BLEU/ ROUGE/ VERT/ ORANGE/  
VIOLET VENDU AVEC LA COCOTTE**

FOLDABLE BRAKE OR CLUTCH LEVER BLACK/ BLUE/ RED/ GREEN/ ORANGE/ PURPLE  
SOLD WITH BRACKET

01 № LFP21-COLOR (FREIN/BRAKE)  
02 № LEP21-COLOR (EMBRAYAGE/ CLUTCH)

€ 35

€ 39



**LEVIER FREIN OU EMBRAYAGE REPLIABLE  
VENDU AVEC LA COCOTTE**

FOLDABLE BRAKE OR CLUTCH LEVER  
SOLD WITH BRACKET

01 № LEPLIABLE (EMBRAYAGE/ CLUTCH)  
02 № LFPLIABLE (FREIN/ BRAKE)

€ 25

€ 25



**POIGNÉE DE GAZ À TIRAGE RAPIDE YCF (VENDU AVEC  
LES 2 POIGNÉES)**

YCF QUICK-ACTION THROTTLE TUBE ( INCLUDE GRIP )

01 № YC110-0138-03

€ 25

**POIGNÉE DE GAZ AVEC RÉGLAGE (VIS DE BRIDAGE)**

THROTTLE TUBE WITH ADJUSTMENT SCREW ( POWER  
CONTROL )

02 № YC110-0138-04 (Vendu avec les 2 poignées)

€ 25

02 № YC110-0138-10 (Grip 19mm) YCF 50AE 2026

€ 25

**VIS M5X50 POUR RÉGLAGE DE LA POIGNÉE DE GAZ**

SCREW FOR THROTTLE ADJUSTMENT, SIZE M5X50

03 № YC110-01022-06

€ 3

**NEW  
2026**



**POIGNÉE DE GAZ**

THROTTLE TUBE

01 № YC110-0138-12 (Grip 19mm) W50 2026

€ 39

02 № YC110-0138-13 W50 2017-2025/ W88

€ 39



**LEVIER FREIN PLIABLE**  
FOLDABLE BRAKE LEVER

N° YC110-0517-01

€ 15



**LEVIER D'EMBRAYAGE + COCOTTE AVEC MOLETTE RAPIDE (2020-26)**

CLUTCH LEVER + BRACKET WITH FAST WRENCH ADJUSTER (2020-26)

N° YC110-0135-02

€ 19



**COCOTTE D'EMBRAYAGE**  
CLUTCH BRACKET

01 N° YC110-0134-04 (2020-26)

€ 15

**LEVIERS FREIN & EMBRAYAGE**  
BRAKE & CLUTCH LEVERS

- 03 N° YC110-0103-07 (EMBR./ CLUTCH) (PILOT/ SM/ FACTORY/ BIGY 2020-26) € 9
- 04 N° YC110-0501-014 (FREIN/ BRAKE) (2005-17) € 8
- 05 N° YC110-0103-03 (EMBR./ CLUTCH) (2005-17) € 8

**CAOUTCHOUC DE LEVIER FREIN & EMBRAYAGE**  
RUBBER BRAKE & CLUTCH LEVERS

- 06 N° YC110-0502-01 (FREIN/ BRAKE)
- 07 N° YC110-0103-10 (EMBRAYAGE/ CLUTCH) € 3

**LEVIER FREIN RÉGLABLE POUR KIT FREIN 4 PISTONS**  
ADJUSTABLE BRAKE LEVER FOR 4 PISTONS BRAKE KIT

02 N° YC110-0501-012

€ 9



**POIGNÉES CAOUTCHOUC YCF (X2)**  
NOIRE/ BLEUE/ ROUGE/ VERTE/ JAUNE/ ORANGE/ ROSE/ BLANCHE/ GRISE

YCF RUBBER GRIPS (X2) BLACK/ BLUE/ RED/ GREEN/ YELLOW/ ORANGE/ PINK/ WHITE/ GREY

N° PPC011-COLOR

€ 12



**POIGNÉES CAOUTCHOUC YCF (X2)**  
NOIRE/ ROUGE/ VERTE/ JAUNE/ ORANGE/ ROSE/ GRISE

YCF RUBBER GRIPS (X2) BLACK/ RED/ GREEN/ YELLOW/ ORANGE/ PINK/ GREY

N° BB12-PPC014-COLOR (YCF 50 2026) (19mm)

€ 12



**DONUTS (X2) NOIR/ ROUGE/ JAUNE/ ORANGE/ BLEU**  
GRIP DONUTS (X2) BLACK/ RED/ YELLOW/ ORANGE/ BLUE

N° DONUTZ-02-COLOR

€ 5



**LEVIER FREIN COMPLET AVEC COCOTTE POUR YCF 50**  
BRAKE LEVER COMPLETE WITH BRACKET FOR YCF 50

- 01 N° YC50-0501 (AVANT/ FRONT) (YCF 50 2012-19) € 10
- 02 N° YC50-01031 (ARRIÈRE/ REAR) (YCF 50 2012-19) € 10
- 03 N° YC50-0503-05 (FREIN AVANT/ FRONT BRAKE) (YCF 50 2020-26) € 8
- 04 N° YC50-0503-06 (FREIN ARRIÈRE/ REAR BRAKE) (YCF 50 2020-26) € 8



**CÂBLE EMBRAYAGE**  
CLUTCH CABLE

- 01 N° YC110-0107 (SM125 2021-26/ PILOT 125 2022-26/ GP 125/ GP 187) € 12
- 01 N° YC110-0108 (SM 155 2020-26/ GP 187) € 12
- 01 N° YC110-0109-22 (SP2/ SP3/ BIGY 125 MX 2021-26/ BIGY 150 MX/ BIGY F150E/ BIGY F190 MX) € 12
- 01 N° 14020500 (PILOT 150E/ SUNDAY 147) € 12
- 02 N° YC110-0109-11 (LITE 125/ START 125) € 12



**CÂBLE DE GAZ**  
THROTTLE CABLE

- N° YC110-0106 (LITE 88/ LITE 125/ START 88SE/ START 125SE/ START 125/ PILOT 125/ PILOT 150E/ SP2/ SP3/ SM 125/ SM 155/ SUNDAY 147 2018-20/ SUNDAY 187 2018-20/ GP 107A/ GP 124/ GP 157/ GP 187) € 12
- N° YC50-0106-14 (FOR 50 ONLY) € 12
- N° YC110-0106-15 (SM 190/ BIGY/ SUNDAY 147 2021-22/ SUNDAY 187 2021-22) € 12

# FOURCHES FORKS



## KIT RÉFECTION FOURCHE TAILLE 33/46/11 : 1 JOINT SPY/ 1 CACHE POUSSIÈRE/ 1 BAGUE INF/ 1 BAGUE SUP

FORK REPAIR KIT SIZE 33/46/11 INCLUDING: 1 FORK OIL SEAL/ 1 DUST COVER/ 1 LOWER RING/ 1 UPPER RING

N° YC110-0470

€ 19

## JOINT SPY FOURCHE

FORK OIL SEAL

01 N° YC50-0415 (POUR/ FOR 50 - 25X25X10)

€ 8

01 N° YC110-0440 (33\*46\*11) START/ PILOT/ FACTORY/ BIGY

€ 9



## TÉ FOURCHE COMPLET 170MM SP3 48/48 (AVEC PONTETS GUIDON 28,6mm) (NOIR/ BLEU/ ROUGE/ VERT/ ORANGE/ VIOLET)

TRIPLE CLAMP SET 48/48 170MM SP3  
(WITH BAR MOUNTS 28,6mm)  
(BLACK/ BLUE/ RED/ GREEN/ ORANGE/ PURPLE)

01 N° YC110-0225-05+COLOR

€ 199



## JEU TUBE FOURCHE UPSD RÉGLABLE

ADJUSTABLE FORK

N° YC110-0400-10 (735mm)

€ 359

N° YC110-0400-47 (775mm)

€ 359

N° YC110-0400-35 (800mm)

€ 359



## JEU TUBE FOURCHE UPSD NON RÉGLABLE

UPSD FORK

N° YC110-0400-43 (600mm)

€ 199

N° YC110-0400-41 (660mm)

€ 199

N° YC110-0400-40 (735mm)

€ 199

N° YC110-0400-33 (785mm)

€ 239





**TÉ FOURCHE COMPLET 160mm 45/48 OU 48/48 (NOIR/ BLEU/ ROUGE/ VERT/ ORANGE/ VIOLET)**  
TRIPLE CLAMP SET 160mm 45/48 OR 48/48 (BLACK/ BLUE/ RED/ GREEN/ ORANGE/ PURPLE)

N° YC110-02-053+COLOR (45/48)  
N° YC110-02-049+COLOR (48/48)

€ 199  
€ 199



**JEU DE PONTETS GUIDON YCF 2012-2019**  
BAR MOUNTS FOR YCF 2012-2019

01 N° YC110-0203-05 (LITE/ START/ PILOT/ SM/ BIGY MX) Ø 22,2 € 39  
02 N° YC110-0203-15 (SP3 2016-19/ BIGY 190 DAYTONA 2017-19) Ø 28,6 € 59  
03 N° YC110-0222-01 CALE POUR PONTET GUIDON ÉPAISSEUR 20mm (VENDU PAR PAIRE) (NON RÉGLABLE/ NOT ADJUSTABLE) € 12  
03 N° YC110-0222-02 CALE POUR PONTET GUIDON ÉPAISSEUR 20mm (VENDU PAR PAIRE) (RÉGLABLE/ ADJUSTABLE) € 20



**JEU DE PONTETS GUIDON YCF 2020-26**  
BAR MOUNT FOR YCF 2020-26

04 N° YC110-0203-038 (FACTORY SP3/ BIGY 190 DAYTONA) Ø 28,6 € 59  
05 N° YC110-0203-035 (50/ LITE/ START/ PILOT/ SP2/ BIGY MX) Ø 22,2 € 49  
06 N° YC110-0222-03 CALE POUR PONTETS GUIDON (VENDU PAR PAIRE) € 12  
07 N° GB70-M10x50x1.5W VIS DE PONTET € 5  
08 N° GB70-M10x35x1.5W VIS DE PONTET 50CC € 5



**ÉCROU POUR COLONNE DE DIRECTION**  
STEERING STEM NUT

**01** № YC110-02-09 (NOTCHED/ CRANTÉ)  
**02** № YC110-02-11 (SUPÉRIEUR/ UPPER)

€ 6

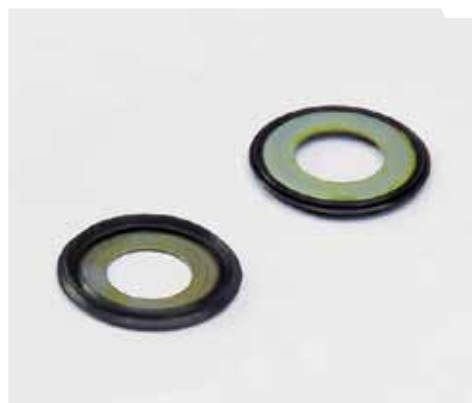

**JOINT POUR COLONNE DE DIRECTION ADAPTABLE**  
**SUR START/ PILOT/ FACTORY/ SM/ BIGY**

SEAL FOR STEERING STEM ADAPTABLE ON START/ PILOT/  
FACTORY/ SM/ BIGY

№ YC110-02-20

€ 6



**JEU DE ROULEMENT COLONNE DIRECTION**  
TAPER ROLLER BEARING FOR STEERING STEM

№ KRDIRIRECTION41-2, YCF50 2012-19 – START 88 2008-19 – LITE88/125 2016-19  
(INFÉRIEUR Ø EXT 41 - INT 24mm/ SUPÉRIEUR Ø EXT 41 - INT 22,5mm)  
№ KRDIRIRECTION46, ALL START 125 – PILOT – FACTORY – BIGY and 50A-E 2020-26 – START 88SE 2020-26  
LITE 88-125 2020-26 (INFÉRIEUR Ø EXT 46 - INT 23,5mm/ SUPÉRIEUR Ø EXT 46 - INT 22mm)

€ 39

€ 39



**ÉCROU POUR COLONNE DE DIRECTION NOIR/ BLEU/ ROUGE/ VERT/ ORANGE/ VIOLET**  
STEERING STEM NUT BLACK/ BLUE/ RED/ GREEN/ ORANGE/ PURPLE

№ ECD-COLOR

€ 12



# CADRES FRAMES



## BÉQUILLE SIDESTAND

01 N° YC50-210-01 (50) (réglable/adjustable 180mm à/to 240mm)  
01 N° YC110-0196-01 (réglable/adjustable 240mm à/to 300mm)  
01 N° YC110-0904-05 (BIGY) € 19

## RESSORT DE BÉQUILLE SIDESTAND SPRING

02 N° YC110-19-01 € 3

## VIS ET ÉCROU BÉQUILLE SIDESTAND SCREW & NUT

03 N° GB6170-M10-G (ÉCROU/ NUT)  
04 N° FB02-M10x1,5x30I (VIS/ SCREW) € 2

## KIT VIS RENFORCÉE POUR MOTEUR ENGINE REINFORCED SCREW SET

05 N° KITVIS8 (Ø 8)  
05 N° KITVIS10 (Ø 10) € 9

## PATTE DE CADRE FRAME STEEL PADS

N° YC110-16-061BK (START F125) € 15  
N° YC110-1622-02BK (PILOT 2014-2026) € 19  
N° YC110-1622-03 (BIGY) € 49



**CADRE RENFORCÉ 88 POUR BRAS MONO  
(BOUCLE ARRIÈRE INCLUSE)**  
88 REINFORCED FRAME FOR MONO SWING ARM  
(REAR SUBFRAME INCLUDED)

N° YC88-161-0301-BK (START SE88) € 149



**BOUCLE ARRIÈRE 88**  
88 REAR SUBFRAME

N° YC88-16-020 (START F88S)  
N° YC88-16-022-BK (START F88SE) € 59



**CADRE RENFORCÉ LITE POUR BRAS CANTILEVER  
(BOUCLE ARRIÈRE INCLUSE)**  
LITE YCF REINFORCED FRAME FOR CANTILEVER SWING  
ARM (REAR SUBFRAME INCLUDED)

N° YC110-161-0301-BK (LITE88) € 179  
N° YC110-161-0401-BK (LITE 125/ 150) € 179



**BOUCLE ARRIÈRE LITE**  
LITE REAR SUBFRAME

N° YC110-1614-23-BK (LITE F88) 2016-2025 € 59  
N° YC110-1614-24-BK (LITE F125/ F150) 2016-2025 € 59



**CADRE START POUR BRAS MONO  
ET AMORTISSEUR 270mm (BOUCLE AR. INCLUSE)**  
START FRAME FOR MONO SWING ARM AND SHOCK  
ABSORBER 270mm (REAR SUBFRAME INCL.)

N° YC110-166-0201-BK (START 125S) € 169



**BOUCLE ARRIÈRE START 125**  
START 125 REAR SUBFRAME PART

N° YC110-16-070BK € 59  
N° YC110-1614-28-BK (START 125SE) € 59



**CADRE COMPLET PILOT 125 & 150 2018-26  
(AXE BRAS Ø 15) (BOUCLE ARRIÈRE INCLUSE)**  
2018-26 PILOT 125 & 150 COMPLET FRAME (ARM AXLE Ø 15)  
(REAR SUBFRAME INCLUDED)

N° YC110-1621-0301-BK (NOIR/BLACK) (axle 15) € 299



**BOUCLE ARRIÈRE PILOT**  
PILOT REAR SUBFRAME

N° YC110-1614-26-BK (2016-26) € 79



**CADRE YCF 2019-2026 FACTORY (BOUCLE AR. INCLUSE)**  
2019-26 FACTORY YCF FRAME (REAR SUBFRAME INCL.)

N° YC110-1621-0801-BK (CADRE 22°) € 329



**BOUCLE ARRIÈRE FACTORY**  
FACTORY REAR SUBFRAME

N° YC110-1614-15-BK (2016-26 ACIER/ STEEL) € 79  
N° YC110-1614-18 (2016-26 ALUMINIUM) € 99



**CADRE YCF 2018-26 BIGY (AXE BRAS Ø 15) (BOUCLE  
ARRIÈRE INCLUSE)**  
2018-26 BIGY YCF FRAME (ARM AXLE Ø 15) (REAR SUBFRAME  
INCLUDED)

N° YC110-1621-0201-BK (COMPLET) € 349



**BOUCLE ARRIÈRE BIGY**  
BIGY REAR SUBFRAME

N° YC110-1614-08-BK (ACIER/ STEEL) € 99  
N° YC110-1614-09-BK (190ZE/ F150E 2022-26) € 99

# SELLES SEATS

**FACTORY**  
SPECIAL PARTS  
YCF RACING



**SELLE COMPLÈTE ANTI DÉRAPANTE RENFORCÉE BLEUE/ ROUGE/ VERTE/ JAUNE/ ORANGE**  
COMPLETE NON-SLIP REINFORCED SEAT BLUE/ RED/ GREEN/ YELLOW/ ORANGE

N° YC110-1401-12+COLOR (BIGY)

€ 89

**FACTORY**  
SPECIAL PARTS  
YCF RACING



**SELLE COMPLÈTE ANTI DÉRAPANTE RENFORCÉE BLEUE/ ROUGE/ VERTE/ JAUNE/ ORANGE**  
COMPLETE NON-SLIP REINFORCED SEAT BLUE/ RED/ GREEN/ YELLOW/ ORANGE

N° YC110-1401-08+COLOR ( LITE 88-125 2016-26, START 2009-26, PILOT 125 2013-14)

N° YC110-1401-07+COLOR (LITE 150 2026, PILOT 125 2015-26, PILOT 150, FACTORY, SM 150)

€ 69

€ 79



**SELLE YCF POUR BIGY**  
YCF SEAT FOR BIGY

N° YC110-1401-11

€ 79

**FACTORY**  
SPECIAL PARTS  
YCF RACING



**SELLE YCF LONGUE LITE 150 2026/ PILOT 125 2015-26/  
PILOT 150 2013-26/ FACTORY 2012-26/ SM 150 2013-26/  
SM 190 2023-26**

YCF LONG SEAT LITE 150 2026/PILOT 125 2015-26/ PILOT 150 2013-26/ FACTORY 2012-26/ SM 150 2013-26/ SM 190 2023-26

N° YC110-1401-17

€ 69



FOR 50 ONLY

01

02



**SELLE YCF 50**  
YCF 50 SEAT

01 N° YC50-1401-05

02 N° YC50-1401-03 (HAUTE/ HIGH + 4 cm)

€ 39

€ 39



**SELLE LITE 88-125 2016-26/ START 2009-26/ PILOT 125  
2013-14/ W88 2020-26**

SEAT LITE 88-125 2016-26/ START 2009-26/ PILOT 125  
2013-14/ W88 2020-26

N° YC110-1401-21

€ 49



**SELLE BASSE YCF POUR LITE 88-125 2016-26/ START  
2009-26/ PILOT 125 2013-14**

YCF LOW SEAT FOR LITE 88-125 2016-26/ START 2009-26/  
PILOT 125 2013-14

N° YC110-14013

€ 49



# RÉSERVOIRS FUEL TANKS



**RÉSERVOIR ET COUVRE RÉSERVOIR YCF POUR BIGY**  
YCF FUEL TANK AND TANK COVER FOR BIGY

01 N° YC110-0701-04  
02 N° YC110-0719-01

€ 59  
€ 15



**RÉSERVOIR YCF (ADAPTABLE SUR TOUTES LES ANCIENNES YCF ET SUR LES MINIS AVEC RÉSERVOIR TYPE CRF 50)**

YCF FUEL TANK (CAN BE ADAPTED TO ALL PREVIOUS YCF AND TO MINI-BIKES WITH A TYPE CRF 50 FUEL TANK)

N° YC110-0701-01

€ 45



**RÉSERVOIR POUR YCF 50**  
FUEL TANK FOR YCF 50

N° YC50-07012

€ 39



**BOUCHON RÉSERVOIR ALUMINIUM YCF NOIR/ BLEU ROUGE/ VERT/ ORANGE/ VIOLET**

YCF ALUMINUM GAS CAP BLACK/ BLUE / RED/ GREEN ORANGE/ PURPLE

N° BOUCHONALU-COLOR

€ 35



**VALVE PRISE AIR NOIRE/ BLEUE/ ROUGE/ VERTE/ ORANGE/ VIOLET**

FUEL VENT VALVE BLACK/ BLUE/ RED/ GREEN/ ORANGE/ PURPLE

N° YC125-0704-COLOR

€ 9



**DURITE ESSENCE NOIRE/ BLEU/ ROUGE/ VERT/ JAUNE/ ORANGE/ ROSE/ BLANCHE**

FUEL LINE BLACK/ BLUE/ RED/ GREEN/ YELLOW/ ORANGE/ PINK/ WHITE

N° DC-COLOR

€ 7



**ROBINET ESSENCE**  
FUEL PETCOCK

N° YC110-0703 (1 EXIT FOR YCF/ 1 SORTIE POUR YCF)

€ 25



**BOUCHON ET JOINT RÉSERVOIR PLASTIQUE**  
GAS CAP AND SEAL

01 N° YC110-0702-01 (YCF ORIGINAL DESIGN)  
02 N° YC110-0720-02

€ 15  
€ 3

# FREINS BRAKES



**PATTE DE FREIN CNC POUR ÉTRIER RADIAL**  
CNC ALUMINUM BRACKET FOR RADIAL BRAKE CALIPER

01 N° YC110-0510-06-SI (AV./FR. FOR DISK 220 MM)  
01 N° YC110-0510-07-SI (AV./FR. FOR DISK 240 MM)  
02 N° YC110-1210-06-SI (ARR./ REAR) € 39

**RESSORT ANTI VIBRATION  
POUR ÉTRIER RADIAL ARRIÈRE**  
REAR SPRING ANTI VIBRATION  
FOR REAR CNC RADIAL BRAKE

03 N° YC110-1256-02 € 5

**RESSORT PLAQUETTE DE FREIN  
POUR ÉTRIER RADIAL AVANT**  
BRAKE PADS SPRING FOR FRONT CNC RADIAL BRAKE

04 N° YC110-0556-02 € 5

**AXE DE PLAQUETTE DE FREIN POUR ÉTRIER RADIAL**  
BRAKE PADS AXLE FOR CNC RADIAL BRAKE

05 N° YC110-0555-02 (AVANT/ FRONT) € 4  
06 N° YC110-1255-02 (ARRIÈRE/ REAR) € 4



**KIT FREIN AVANT RADIAL - KIT FREIN ARRIÈRE RADIAL**  
RADIAL FRONT BRAKE KIT - RADIAL REAR BRAKE ASSEMBLY

01 N° YC110-05012-09BK (AVANT/ FRONT) € 149  
02 YC110-12012-08BK (ARRIÈRE/ REAR) € 149



**KIT FREIN ARRIÈRE AU POUCE**  
THUMB BRAKE

N° YC110-1212-13 € 99



**MAÎTRE CYLINDRE FREIN AVANT SUPERMOTARD**  
SUPERMOTARD FRONT BRAKE MASTER CYLINDER

N° YC110-0507-01 € 99



**LEVIER FREIN SEUL POUR MAÎTRE CYLINDRE FREIN AVANT SM**  
SM BRAKE LEVER FOR FRONT BRAKE MASTER CYLINDER

N° YC110-0503-02 € 30

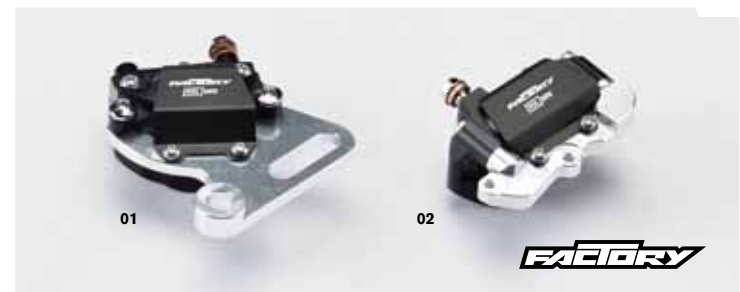

**ÉTRIER FREIN CNC RADIAL FACTORY**  
FACTORY BRAKE CALIPER RADIAL CNC

01 N° YC110-1201-06-BK (ARRIÈRE/ REAR)  
02 N° YC110-0502-06-BK (AVANT/ FRONT) € 115



**KIT FREIN AVANT FACTORY (LEVIER RÉGLABLE) 2016-26**  
 FACTORY FRONT BRAKE KIT (AJUSTABLE LEVER) 2016-26

N° YC110-0501-3101 (SP2/ SP3/ BIGY) € 89



**KIT FREIN ARRIÈRE FACTORY 2016-2026**  
 FACTORY REAR BRAKE ASSEMBLY 2016-2026

N° YC110-12012-2601 (SP2/ SP3)  
 N° YC110-12012-2801 (BIGY FACTORY) € 90



**KIT FREIN ARRIÈRE HYDRAULIQUE YCF 50 2020-26 (ADAPTABLE SUR LES YCF 50 2012-2019)**  
 HYDRAULIC REAR BRAKE KIT YCF 50 2020-26 (CAN FIT ON YCF 50 2012-2019)

N° YC50-1214-03 € 79



**KIT FREIN AVANT HYDRAULIQUE YCF 50 2020-26 (ADAPTABLE SUR LES YCF 50 2012-2019)**  
 HYDRAULIC FRONT BRAKE KIT YCF 50 2020-26 (can fit on YCF 50 2012-2019)

N° YC50-0511-03 € 79





**ÉTRIER FREIN AVANT**  
FRONT BRAKE CALIPER

- 01 N° YC110-0501-0205 (DOUBLE PISTON) (START 125-BIGY 125-150 MX) € 59
- 02 N° YC50-0502 (YCF 50) € 39
- 06 N° YC110-0501-0207 (SP3 2016-26 - BIGY FACTORY 150-190) € 69

**MAITRE CYLINDRE AVANT**  
FRONT BRAKE MASTER CYLINDER

- 03 N° YC110-0501-0103 (FREINAGE À GAUCHE) € 49
- 03 N° YC110-0501-0104-02 (DOUBLE PISTON) (LITE/ START) € 49
- 05 N° YC110-0501-0101 (4 PISTONS) € 49
- 04 N° YC110-0501-0104-03 (PILOT/ FACTORY/ BIGY 2016-26) € 59

**DURITE FREIN AVANT**  
FRONT BRAKE HOSE

- 05 N° YC110-0501-0325 (FILETAGE AU MAÎTRE CYLINDRE) (LITE/START) € 29
- 05 N° YC110-0501-0327 (BANJO AU MAÎTRE CYLINDRE) (SP2/ SP3/ BIGY)



**KIT FREIN COMPLET AVANT AVEC ÉTRIER DOUBLE PISTON**  
COMPLETE FRONT BRAKE KIT WITH DOUBLE PISTON CALIPER

- N° YC110-0501-1801 (LITE/ START 125)
- N° YC110-0501-3301 (BIGY/ PILOT/ SM F150)

€ 79



**KIT FREIN AVANT COMPLET START F88**  
COMPLETE FRONT BRAKE KIT START F88

- N° YC110-0501-2001 (START 88 2020-26)

€ 79





**ÉTRIER FREIN ARRIÈRE**

REAR BRAKE CALIPER

- 01 N° YC110-1201-0401 (1 PISTON) (LITE/ START/ PILOT/ BIGY 125-150 MX) € 59
- 06 N° YC110-1201-07 (SP3 2016-26/ BIGY FACTORY 150-190) € 69

**MAÎTRE CYLINDRE FREIN ARRIÈRE**

REAR BRAKE MASTER CYLINDER

- 02 N° YC110-1201021 (Ø 8/ DIST. 40mm) (START) € 30
- N° YC110-1201023 (Ø 10/ DIST. 40mm) (SM 190) € 30
- N° YC110-1201026 (Ø 10/ LITE) € 30
- N° YC50-1201 (YCF50) pour frein à câble / for brake cable € 39
- 05 N° YC110-1201024 ( PILOT/ FACTORY / BIGY ) € 39

**JEU DE CAOUTCHOUCS ÉTRIER FREIN ARRIÈRE**

SET OF REAR BRAKE CALIPER RUBBER

- 03 N° YC110-120110 € 5

**DURITE FREIN ARRIÈRE Ø 10 ÉTRIER**

REAR BRAKE HOSE CONNECTION Ø 10 CALIPER

- 04 N° YC110-1201061 (Ø 8 MASTER CYLINDER) 370mm (START)
- 04 N° YC110-1201062 (Ø 8 MASTER CYLINDER) 465mm (PILOT)
- 04 N° YC110-1203-04 (Ø 10/ MASTER CYLINDER) 425 (LITE)
- 04 N° YC110-1201052 (Ø 10/ MASTER CYLINDER) 465mm (SP2)
- 04 N° YC110-1201063 (Ø 10/ MASTER CYLINDER) 515mm (SP3/ BIGY) € 19



**KIT FREIN COMPLET ARRIÈRE 1 PISTON**

COMPLETE REAR BRAKE ASSEMBLY

- N° YC110-12012-0601 (START) € 79
- N° YC110-12012-3101 (LITE) € 79
- N° YC110-12012-2701 (BIGY) € 79
- N° YC110-12013-0301 (360 mm START 88SE 2020-26) € 79
- N° YC110-12012-2401 (PILOT/ SM F150) € 79



**MAÎTRE CYLINDRE AVEC BOCAL**

MASTER CYLINDER WITH RESERVOIR

- N° YC110-120102 € 35



**FREIN ARRIÈRE AU GUIDON GP**

REAR BRAKE HANDLE BAR GP

- N° YC110-12012-34 € 89



**FACTORY**

**PÉDALE DE FREIN PILOT/FACTORY/BIGY AVEC ROULEMENT**

PILOT/FACTORY/BIGY BRAKE PEDAL WITH BEARING

N° YC110-219-03

€ 49



**FACTORY**

**PÉDALE DE FREIN PILOT/FACTORY/BIGY AVEC ROULEMENT**

PILOT/FACTORY/BIGY BRAKE PEDAL WITH BEARING

N° YC110-219-03-BK

€ 49



**EMBOU PÉDALE FREIN ALUMINIUM NOIR/ BLEU/ ROUGE/ VERT/ ORANGE/ VIOLET**

COLOR REAR BRAKE LEVER TIPS BLACK/ BLUE/ RED/ GREEN/ ORANGE/ PURPLE

N° YC110-1223-02-COLOR

€ 15



**PROTECTION MAÎTRE CYLINDRE FREIN ARRIÈRE POUR LITE/ START 2007-26/ PILOT/ FACTORY 2007-15**

REAR BRAKE MASTER CYLINDER GUARD FOR LITE/ START 2007-26/ PILOT/ FACTORY 2007-15

N° YC110-1224

€ 15



**START**

**PÉDALE FREIN ALUMINIUM POUR 88/125 START**

ALUMINIUM BRAKE PEDAL FOR 88/125 START

N° YC110-218

€ 49



**START**

**PÉDALE FREIN ACIER POUR START 88/125 / LITE 2026**

STEEL BRAKE PEDAL FOR 88/125 START/ LITE 2026

N° YC110-211

€ 25



**PÉDALE DE FREIN ACIER**

STEEL BRAKE PEDAL

N° YC110-217-02 (PILOT/ SM150 2013-26)

€ 25



**FOR 50 ONLY**



**KIT PÉDALE FREIN AU PIED POUR YCF 50 2012-26**

BRAKE PEDAL KIT FOR YCF 50 2012-26

N° YC50-1219

€ 49



**PÉDALE DE FREIN ALUMINIUM HAUT DE GAMME 2010-2011-CLASSIC 2012**

ALUMINIUM BRAKE PEDAL HIGH-RANGE 2010-2011-CLASSIC 2012

N° YC110-215

€ 49



**CHAPE MAÎTRE CYLINDRE FREIN ARRIÈRE CNC NOIR/ BLEU/ ROUGE/ VERT/ ORANGE/ VIOLET**

CNC REAR BRAKE CLEVIS BLACK/ BLUE/ RED/ GREEN/ ORANGE/ PURPLE

01 N° EMC-COLOR

02 N° EMC01-COLOR (PILOT/ FACTORY/ BIGY 2016-26) € 15



**EMBOU PÉDALE FREIN**

REAR BRAKE LEVER TIPS

01 N° YC110-1223-01 (ACIER/ STEEL) € 6

02 N° YC110-1223-02 (ALUMINIUM) € 15

**CÂBLE DE PÉDALE DE FREIN ARRIÈRE AVEC GAINÉ (POUR ÉVITER DE TORDRE LA PÉDALE DE FREIN)**

REAR BRAKE PEDAL CABLE WITH SHEATH (TO AVOID BRAKE PEDAL TWISTING)

03 N° YC110-1260-01 € 8

**RESSORT PÉDALE FREIN**

BRAKE PEDAL SPRING

04 N° YC110-21-01 (ACIER/ STEEL)

04 N° YC110-21-06 (ALUMINIUM FACTORY) € 5

# FACTORY 190 SP3

YCF FACTORY DAYTONA 190 ANIMA  
RIDER : CLÉMENT CALLEY  
TEAM : YCF France





**DISQUE DE FREIN ENTRAXE 102,5mm Ø INT. 76mm**  
BRAKE DISC CENTER TO CENTER DISTANCE 102,5mm  
INNER Ø 76mm

Nº YC110-1115-06 (ARRIÈRE/ REAR 200mm PERCÉ EN 10mm) € 39  
Nº YC110-1115-07 (AVANT/ FRONT 220mm PERCÉ EN 10mm) € 39



**KIT VIS INOX POUR DISQUE DE FREIN**  
INOX BOLT KIT FOR BRAKE DISC

01 Nº KVD-01 (DIAM 10) € 5  
02 Nº KVD (DIAM 8) € 3,5



**DISQUE FREIN AVANT FLOTTANT 220mm**  
SEMI FLOATING BRAKE ROTOR 220mm

Nº YC110-0613-01-BK € 99



**DISQUE DE FREIN AVANT 240mm AVEC PATTE DE DÉPORT**  
240mm FRONT BRAKE DISC WITH LEG OFFSET

Nº KS2 € 69



**DISQUE DE FREIN AVANT FLOTTANT 240mm AVEC PATTES DE DÉPORT**

240mm SEMI FLOATING BRAKE ROTOR WITH CALIPER MOUNTING BRACKETS KIT

Nº KS2-1 € 129



**JEU DE PLAQUETTES FREIN AV. & AR. POUR YCF 50**  
SET OF BRAKE PADS FRONT & REAR FOR YCF 50

01 Nº YC50-0506 (2012-2019) € 15  
13 Nº YC50-0506-02 (YCF 50 2020-26 HYDRAULIQUE) € 16

**JEU DE PLAQUETTES FREIN ARRIÈRE**  
REAR BRAKE PADS

02 Nº 14030213/4N (YCF 2005) € 19  
09 Nº YC110-1204-02 (SP 2016-26/ BIGY/ FACTORY 2017-26)

**JEU DE PLAQUETTES FREIN AR. 1 PISTON YCF**  
REAR BRAKE PADS SINGLE 1 PISTON YCF

03 Nº YC110-120104 (START 2012-26/ LITE 2016-26) € 15

**JEU DE PLAQUETTES FREIN AVANT YCF 2005**  
FRONT BRAKE PADS YCF 2005

04 Nº 14010114/5 € 15

**JEU DE PLAQUETTES FREIN AVANT/ARRIÈRE POUR ÉTRIER 4 PISTONS POUR YCF 2007 ET 88 2009-11**  
BRAKE PADS FRONT/REAR FOR 4 PISTONS CALIPER FOR YCF 2007 AND 88 2009-11

05 Nº YC110-0501-0401 € 15

**JEU DE PLAQUETTES FREIN AVANT**  
FRONT BRAKE PADS

06 Nº YC110-0501-0406 € 15  
10 Nº YC110-0501-0416 (SP 2016-26/ BIGY/ FACTORY 2017-26) € 19

**JEU DE PLAQUETTES SIMPLE PISTON POUR YCF 2006**  
BRAKE PADS SINGLE PISTON FOR YCF 2006

07 Nº YC110-0501-0402 € 15

**JEU DE PLAQUETTES FREIN AVANT YCF 2008-26**  
FRONT BRAKE PADS YCF 2008-26

08 Nº YC110-0501-0403 € 19

**VIS PLAQUETTE FREIN AVANT OU ARRIÈRE**  
FRONT OR REAR BRAKE PADS SCREW

14 Nº YC110-1255 (ARRIÈRE/ REAR) LITE/ START/ PILOT/ BIGY AVANT/BEFORE 2021 € 3  
15 Nº YC110-0555 (AVANT/ FRONT) START 2008-19/PILOT 2013-19/ FACTORY 2013-15/ SM 2010-19/ BIGY MX 2017-19 € 3  
16 Nº YC110-0555-01 (AVANT/FRONT-ARRIÈRE/REAR) SP A PARTIR - FROM 2016/ BIGY FACTORY € 3  
17 Nº YC110-1255-04 (ARRIÈRE/REAR) LITE/ START/ PILOT/ BIGY MX 2021 € 3

**JEU DE PLAQUETTES FREIN RADIAL AV. & AR.**  
SET OF RADIAL BRAKE PADS FRONT & REAR

11 Nº YC110-0506-01 (AVANT/ FRONT) € 15  
12 Nº YC110-1204-01 (ARRIÈRE/ REAR)



**CAPOT MAÎTRE CYLINDRE FREIN AVANT CNC**  
**NOIR/ BLEU/ ROUGE/ VERT/ ORANGE/ VIOLET**  
 FRONT BRAKE RESERVOIR COVER BLACK/ BLUE/ RED/ GREEN/ ORANGE/ PURPLE

01 N° FBRC01-COLOR (PILOT/ FACTORY/ BIGY 2016-26) € 15  
 02 N° FBRC-COLOR (ALL YCF MODELS EXCEPT PILOT/ FACTORY 2016-2026) € 15



**CAPOT MAÎTRE CYLINDRE FREIN ARRIÈRE CNC**  
**NOIR/ BLEU/ ROUGE/ VERT/ ORANGE/ VIOLET**  
 REAR BRAKE RESERVOIR COVER BLACK/ BLUE/ RED/ GREEN/ ORANGE/ PURPLE

01 N° RBRC01-COLOR (PILOT/ FACTORY/ BIGY 2016-26) € 15  
 02 N° RBRC-COLOR (ALL YCF MODELS EXCEPT PILOT/ FACTORY 2016-2026) € 15

# BRAS OSCILLANTS SWING ARMS



**DIABOLO CNC NOIR/ BLEU/ ROUGE / VERT/ ORANGE**  
CNC REAR SPOOL BLACK/ BLUE/ RED/ GREEN/ ORANGE

N° KRS-COLOR

€ 15



**FACTORY**  
SPECIAL PARTS  
YCF RACING

**BRAS OSCILLANT MONO ALU RENFORCÉ**  
ALUMINUM REINFORCED MONO SWING ARM

N° YC110-10015-0101 (420mm POUR/ FOR SP2 2014-2026/ SP3 2014-18)  
N° YC110-1001-2102 (460mm POUR/ FOR SP3 2019-26)  
N° YC110-1001-1603 (460mm, AXE 15 POUR/ FOR BIGY 2018-26)  
N° YC110-1001-23 (490mm, AXE 15 POUR/ FOR BIGY SM 17/17 ou BIGY MX 16/19)

€ 249  
€ 249  
€ 249  
€ 259



**START**

**BRAS OSCILLANT MONO CHROMOLY START**  
START MONO CHROMOLY SWING ARM

N° YC110-1001-0701 (350mm) (START 88)  
N° YC110-10014-01 (390mm) (START 125)

€ 99  
€ 119



**BRAS OSCILLANT MONO CHROMOLY**  
CHROMOLY MONO SWING ARM

N° YC110-1001-1701 (420mm, AXE 15 POUR/ FOR PILOT 2018-26)  
N° YC110-1001-1501 (460mm, AXE 15 POUR/ FOR BIGY 2018-26)

€ 179





**PROTÈGE DISQUE ARRIÈRE RENFORCÉ NYLON**  
REINFORCED NYLON REAR DISC GUARD

N° YC110-1024-04

€ 29



**PROTÈGE DISQUE ARRIÈRE**  
REAR DISC GUARD

N° YC110-1010

€ 15



**VIS ET ÉCROU TENDEUR DE CHAÎNE**  
BOLT AND NUT FOR BLOCK AXLE

01 N° GB5783-M8X40-W (VIS/ SCREW)  
02 N° FB6170-M8-W (ÉCROU/ NUT)

€ 3

€ 2



**AXE BRAS OSCILLANT**  
AXLE SWING ARM

01 N° YC110-10-034 (Ø 12/ L: 192mm: START)  
01 N° YC110-10-037 (Ø 12/ L: 205mm: LITE)  
01 N° YC110-10-033 (Ø 12/ L: 236mm: FACTORY 2012-26)  
01 N° YC110-10-035 (Ø 12/ L: 240mm: PILOT)  
02 N° YC110-1009-01 (Ø 15: PILOT/ BIGY 2018-26)

€ 6

**ROULEMENT BRAS OSCILLANT**  
SWING ARM BEARING

03 N° 6200/30-10 (Ø EXT, 30/ Ø INT, 10)  
03 N° 6001/28-10 (Ø EXT, 28/ Ø INT, 10)  
03 N° 6001/28-12-08 (Ø EXT, 28/ Ø INT, 12)(START/ FACTORY)  
03 N° 6001/28-15-08 (Ø EXT, 28/ Ø INT, 15) (PILOT/ BIGY 2018-26)

€ 6



**ROULETTE CHAÎNE**  
CHAIN TENSIONER

01 N° YC110-2201-02  
01 N° YC50-2201-02 (50E-W88)  
01 N° YC110-2201-03 (SP3)

€ 12

€ 12

€ 15

**GUIDE CHAÎNE ARRIÈRE**  
REAR CHAIN GUIDE

02 N° YC110-1004 (PILOT 2012-24 - BIGY 2017-24)  
03 N° YC110-1005 (START - LITE) SE MONTE SUR TOUS LES MODÈLES À PARTIR DE 2025/ ALL MODELS FROM 2025

€ 29



**FACTORY**  
SPECIAL PARTS  
YCF RACING

**GUIDE CHAÎNE RENFORCÉ FACTORY 2019-24 ADAPTABLE SUR TOUTES LES PILOT/ FACTORY/ BIGY**

2019-24 FACTORY REINFORCED CHAIN GUIDE SUITABLE FOR ALL PILOT/ FACTORY/ BIGY

N° YC110-1018-04

€ 39



**PATIN CHAÎNE START 2011-2026**

CHAIN SLIDER FOR START 2011-2026

01 N° YC110-10-023

€ 15

**PATIN BRAS OSCILLANT POUR BRAS 420mm OU 460mm 2011-2026**

SWING ARM SLIDER FOR 420mm OR 460mm ARM 2011-2026

02 N° YC110-10-025 (TOUS LES MODÈLES À PARTIR DE 2026/ ALL MODELS FROM 2026) € 15

**PATIN BRAS OSCILLANT CANTILEVER LITE**

LITE CANTILEVER SWING ARM SLIDER

03 N° YC110-1005-02

€ 15

**PATIN CHAÎNE COURT POUR BRAS CANTILEVER**

SHORT CHAIN SLIDER ADAPTABLE FOR CANTILEVER ARM

04 N° YC110-10-021

€ 10

# AMORTISSEURS SHOCK ABSORBERS

**FACTORY**  
SPECIAL PARTS  
YCF RACING

**NEW  
2026**



**AMORTISSEUR**  
SHOCK ABSORBER

01	N° YC50-0404-03 (200mm YCF 50)	€ 89
02	N° YC110-0404-82 (270mm CANTILVER - LITE 88 - 125)	€ 129
03	N° YC110-0404-15 (265mm MONO ARM/ BRAS - START F88)	€ 129
03	N° YC110-0404-14 (270mm MONO ARM/ BRAS - START F125)	€ 129
03	N° YC110-0404-17 (310mm MONO ARM/ BRAS - PILOT 125/150 2013-20 & SM150 2013-26)	€ 139
03	N° YC110-0404-81 (330mm MONO ARM/BRAS PILOT 125/150 2020-26)	€ 139
03	N° YC110-0404-67 (355mm MONO ARM/ BRAS - BIGY)	€ 139
04	N° YC110-0404-07 (280mm RÉGLABLE/ ADJUSTABLE)	€ 199
04	N° YC110-0404-16 (330mm RÉGLABLE/ ADJUSTABLE - SP2)	€ 199
04	N° YC110-0404-68 (355mm RÉGLABLE/ ADJUSTABLE - BIGY)	€ 199
07	N° YC110-0404-101-WH (265mm LITE 88 2026)	€ 99
07	N° YC110-0404-102-WH (270mm LITE 125 2026)	€ 99
07	N° YC110-0404-103-WH (330mm LITE 150 2026)	€ 109

**ENTRETOISE D'AMORTISSEUR Ø 12**  
SHOCK ABSORBER SPACERS Ø 12

05	N° YC110-0419 (START/ PILOT 2010-2026)	€ 4
06	N° YC110-04192 (RSP, CLASSIC, FACTORY 2010-2026)	€ 6



**AMORTISSEUR DNM**  
DNM SHOCK ABSORBER

N° YC110-0404-83	270mm ressort/spring	800lbs	€ 319
N° YC110-0404-84	270mm ressort/spring	1000lbs	€ 339
N° YC110-0404-35	310mm ressort/spring	1000lbs	€ 339
N° YC110-0404-59	330mm ressort/spring	1000lbs	€ 339
N° YC110-0404-99	355mm ressort/spring	800 lbs (BIGY)	€ 339



**RESSORT PLUS SOUPLE ET PLUS DUR**  
SOFTER AND HARDER SPRING

01	N° YC110-0417-22-WH (START/ SM 88-125)	€ 39
	N° YC110-0417-23-WH (PILOT 125-150/ SM 150) (SOUPLE 600 lbs)	€ 39
02	N° YC110-0417-27-BK (START/ SM 88-125)	€ 39
	N° YC110-0417-28-BK (PILOT 125-150/ SM 150) (DUR 800 lbs)	€ 39
03	N° YC110-0417-46-BK 355mm 1000 LBS (BIGY)	€ 39



**BAVETTE D'AMORTISSEUR YCF**  
YCF MUD FLAP

N° YC110-0460-01 (POUR/FORPILOT/ FACTORY/ BIGY) € 15



**KIT RABAISSAGE AMORTISSEUR**  
HEIGHT ADJUSTMENT KIT

01	N° YC110-1033-01 (START 88S-125-125S)	€ 59
02	N° YC110-1030-02 (LITE)	€ 59

# ROUES, JANTES & MOYEUX WHEELS, RIMS & HUBS



**KIT ROUE SUPERMOTO YCF LIVRÉ AVEC ENTRETOISES ET VALVES**  
YCF SUPERMOTO WHEEL SET DELIVERED WITH SPACERS AND VALVES

N° YC110-0625-01-BK (2.15 X 10" AV/ FRONT - 2.50 X 10" AR/ REAR)  
N° YC110-0626-01-BK (2.15 X 12" AV/ FRONT - 2.75 X 12" AR/REAR)

€ 219  
€ 249



**VALVE COUDE 90° SILVER/ NOIR/ BLEU/ ROUGE/ OR/ - VENDUES PAR PAIRE**  
YCF 90° INNER TIRE VALVES SILVER/ BLACK/ BLUE/ RED/ GOLD - SOLD IN PAIRS

N° ITV01-COLOR

€ 15



**ROUE ACIER POUR AXE DE ROUE DE 15" AVEC RAYONS RENFORCÉS 4mm**

STEEL WHEEL FOR 15" WHEEL AXLE WITH 4mm REINFORCED SPOKES

- N° YC110-0601-2901 (AVANT/ FRONT 12") € 119
- N° YC110-0601-3001-BK (AVANT/ FRONT 14") € 119
- N° YC110-0601-0801 (88CC : AVANT/ FRONT 10") € 119
- N° YC110-1101-3401-BK (ARRIÈRE/ REAR 12") € 149
- N° YC110-1101-01A (ARRIÈRE/ REAR 10") € 149



**ROUE AVANT OU ARRIÈRE COMPLÈTE YCF 50**

COMPLETE FRONT OR REAR WHEEL FOR YCF 50

- N° YC50-0601-0401 (AVANT/ FRONT) € 99
- N° YC50-1101-0401 (ARRIÈRE/ REAR) € 139



**ROUE COMPLÈTE AVEC MOYEURS CNC NOIRE/ BLEUE/ ROUGE/ VERTE/ ORANGE**

COMPLETE WHEEL WITH CNC HUB BLACK/ BLUE/ RED/ GREEN/ ORANGE

- N° YC50-0611-01+COLOR (AVANT/ FRONT) € 99
- N° YC50-1101+COLOR (ARRIÈRE/ REAR) € 139



**ROUE COMPLÈTE ACIER RENFORCÉE POUR AXE DE ROUE DE 15", MOYEURS ARRIÈRE AVEC 5 VIS DE FIXATION POUR COURONNE**

COMPLETE REINFORCED STEEL WHEEL AXLE 15", REAR HUB WITH 5 SCREWS FIXATION FOR SPROCKET

- N° YC110-0601-39-BK (AVANT/ FRONT 17") € 139
- N° YC110-1101-29-BK (ARRIÈRE/ REAR 14") € 149



**ROUE AVANT OU ARRIÈRE COMPLÈTE 16"/19" CERCEAU ALUMINIUM**

COMPLETE FRONT OR REAR WHEEL 16"/19" ALUMINIUM RIM

- N° YC110-0601-34-BK (1,60x19" AVANT/ FRONT) € 189
- N° YC110-1101-72-BK (1,85 x16" ARRIERE/ REAR) € 249

ROUE COMPLÈTE RENFORCÉE, MOYEU CNC,  
CERCEAU ALU, 7116, VENDUE AVEC DISQUE & COURONNE  
NOIRE/ BLEUE/ ROUGE/ VERTE/ ORANGE/ VIOLET  
COMPLETE REINFORCED WHEEL, CNC HUB, ALU,  
7116 RIM (SOLD WITH BRAKE DISC & SPROCKET)  
BLACK/ BLUE/ RED/ GREEN/ ORANGE/ PURPLE

14 17

N° YC110-0601-40-COLOR (AVANT/ FRONT 17") € 179  
N° YC110-1101-32-COLOR (ARRIÈRE/ REAR 14") € 229

**FACTORY**  
SPECIAL PARTS  
YCF RACING



**AI 7116**

**YCF**



**ROUE COMPLÈTE RENFORCÉE, MOYEU CNC, CERCEAU ALU, 7116, VENDUE AVEC DISQUE & COURONNE NOIRE/ BLEUE/ ROUGE/ VERTE/ ORANGE/ VIOLET**  
COMPLETE REINFORCED WHEEL, CNC HUB, ALU, 7116 RIM (SOLD WITH BRAKE DISC & SPROCKET) BLACK/ BLUE/ RED/ GREEN/ ORANGE/ PURPLE

N° YC110-0601-37-COLOR (AVANT/ FRONT 14")  
N° YC110-1101-25-COLOR (ARRIÈRE/ REAR 12")

€ 169  
€ 219



**CERCEAU DE ROUE ALU. 7116**  
ALUMINUM 7116 M SHAPE RIM

N° YC110-1107-16-BK (1,85x12" AR./ REAR)	€ 59
N° YC110-1107-16-SI (1,85x12" AR./ REAR)	€ 59
N° YC110-0617-24-BK (2,50x14" AV./ FRONT)	€ 79
N° YC110-0617-24-SI (1,40x14" AV./ FRONT)	€ 79
N° YC110-0617-40-BK (1,60x17" AV./ FRONT)	€ 59
N° YC110-1107-32-BK (1,85x14" AR./ REAR)	€ 59
N° YC110-0617-41-BK (2,50x17")	€ 139
N° YC110-1107-54-BK ( 3,50x17")	€ 149
N° YC110-1107-55-BK ( 2,15x16")	€ 99
N° YC110-0617-42-BK (1.60X19")	€ 99



**CERCEAU DE ROUE ACIER POUR RAYON 4mm**  
STEEL RIM WITH 4mm SPOKES

- N° YC110-1107-34-BK (1,85X12 AR/ REAR) € 30
- N° YC110-1101-014 (2,15X12 AV/ FRONT - AR/ REAR) € 30
- N° YC110-0617-19-BK (1,40x12 AV/ FRONT) € 30
- N° YC110-0617-30-BK (1,40x14 AV/ FRONT) € 30
- N° YC110-0617-39-BK (1,60x17 AV/ FRONT) € 30
- N° YC110-1107-29-BK (1,85x14 AR/ REAR) € 30



**ROULEMENT DE ROUE AVANT OU ARRIÈRE**  
FRONT OR REAR WHEEL BEARING

- 01 N° 96140-6202-2Z BEFORE 2024 € 6
- 01 N° 96140-6003-2Z (2024-26) € 6

**JOINT SPY DE ROUE**  
WHEEL OIL SEAL

- 02 N° YC50-0610 (Ø22X31.5X5) (POUR/ FOR YCF 50)
- 02 N° YC110-0610 (Ø25X35X6.5)  
(POUR MOYEUR CNC 2012/ FOR CNC HUB)
- 02 N° YC110-0611 (Ø23X35X5) (POUR MOYEUR  
INJECTÉ-CNC/ FOR MOLDED-CNC HUB) € 6

**GRIPSTER ARRIÈRE OU AVANT**  
REAR OR FRONT RIM LOCK

- 03 N° GRIPSTERAR-R (ARRIÈRE/ REAR)
- 03 N° GRIPSTERA-V-R (AVANT/ FRONT) € 15



**JEU DE RAYONS AVANT OU ARRIÈRE 4mm**  
FRONT OR REAR SET OF SPOKES 4mm

AVANT/ FRONT:

- N° JR10-10.6 (50A/ 50E)
- N° JR12-12.1-8K (88E/ START 88SE)
- N° JR12-12.5 (SM)
- N° JR10-10.1-8K (LITE 88)
- N° JR14-14.8-8K (LITE 125/ START 125S/ START 125SE  
/ PILOT 125/ PILOT 150)
- N° JR14-15.0-8K (SP2/ SP3)
- N° JR17-18.5-8K (BIGY F150/ 190D/ 190ZE)
- N° JR19-21.3-8K (BIGY 19") € 25

ARRIÈRE/ REAR:

- N° JR10-10.5 (50A/ 50E)
- N° JR10-10.4-8K (88E/ LITE 88/ START 88SE)
- N° JR12-12.8-8K (LITE 125/ START 125S/ START 125SE  
/ PILOT 125/ PILOT 150)
- N° JR12-13.5-8K (SP2/ SP3)
- N° JR12-12.6-10K (SM)
- N° JR14-15-8K (BIGY 125/ 150)
- N° JR14-15.1-8K (BIGY F150/ 190D/ 190ZE)
- N° JR16-17.5-8K (BIGY 16") € 25



**AXE DE ROUE AVANT OU ARRIÈRE**  
FRONT OR REAR WHEEL AXLE

- 01 N° YC110-11-075 (FACTORY 2011-2026)
- 02 N° YC110-11-07 (ARRIÈRE/ REAR)
- 03 N° YC110-06-06 (AVANT/ FRONT - LITE)
- 04 N° YC110-06-061 (TYPE MARZOCCHI®) € 8



**COUVRE RAYON (KIT DE 38 PCS AVANT 215 MM/ 38 PCS ARRIÈRE 190mm)**  
**NOIR/ BLEU/ ROUGE/ VERT/ JAUNE/ ORANGE/ ROSE**

SPOKE SKIN SET (INCLUDES 38 FRONT PCS-215mm & 38 REAR PCS-190mm)  
BLACK/ BLUE/ RED/ GREEN/ YELLOW/ ORANGE/ PINK

N° SPKAS01-COLOR

€ 15



**MOYEU ROUE AVANT OU ARRIÈRE CNC NOIR/ BLEU/ ROUGE/ VERT/ ORANGE/ VIOLET**

WHEEL HUB CNC FRONT OR REAR BLACK/ BLUE/ RED/ GREEN/ ORANGE/ PURPLE

- 01 N° YC110-0622-22+COLOR (AVANT/ FRONT) € 99  
 02 N° YC110-1122-16+COLOR (ARRIÈRE/ REAR) € 119

**JEU ENTRETOISES DE ROUE CNC POUR MOYEU INJECTÉE LITE/ START/ PILOT/ BIGY MX125/150 NOIRES/BLEUES/ ROUGES/ VERTES/ ORANGES**

SET OF CNC WHEEL SPACERS FOR CASTING HUB LITE/ START/ PILOT/ BIGY MX125/150 BLACK/ BLUE/ RED/ GREEN/ ORANGE

- 03 N° ERC1AV-COLOR (AVANT/ FRONT 15x22x33 & 15x22x23) € 15  
 03 N° ERC1AR-COLOR (ARRIÈRE/ REAR 15x22x38 & 15x22x29) € 15

**ENTRETOISE DE ROUE**

WHEEL SPACER

- 04 N° YC110-06-052 (AVANT GAUCHE/ FRONT LEFT) Ø 15X22X33 LITE/ START/ PILOT/ BIGY MX125-150 2016-2023  
 04 N° YC110-06-047 (AVANT DROITE/ FRONT RIGHT) Ø 15X22X23 LITE/ START/ PILOT/ BIGY MX125-150 2016-2023  
 04 N° YC110-11-052 (ARRIÈRE GAUCHE/ REAR LEFT) Ø 15X22X38 LITE/ START/ PILOT/ BIGY MX125-150 2016-2023  
 04 N° YC110-11-041 (ARRIÈRE DROITE/ REAR RIGHT) Ø 15X22X29 LITE/ START/ PILOT/ BIGY MX125-150 2016-2023 € 5

**KIT ENTRETOISE DE ROUE FIXE POUR MOYEU INJECTÉ**

WHEEL SPACER KIT FOR INJECTED HUB

- N° YC110-0635-01 (AVANT/ FRONT) LITE/ START/ PILOT/ BIGY125/ BIGY150MX/ SUPERMOTO/ MINI GP € 29  
 N° YC110-1126-01 (ARRIÈRE / REAR) LITE/ START/ PILOT/ BIGY125/ BIGY150MX/ SUPERMOTO/ MINI GP € 29

**ENTRETOISE CENTRALE DE MOYEU**

CENTRAL HUB SPACER

- 05 N° YC110-0601-02 (CENTRAL AVANT/ FRONT) Ø16x22x44 (LITE/ START/ PILOT/ BIGY 2016-2023)  
 05 N° YC110-0601-0201 (CENTRAL AVANT/FRONT) Ø17X24X44 (START/ PILOT/ BIGY 2025-26)  
 05 N° YC110-0601-0607 (CENTRAL AVANT/FRONT) Ø17X24X44 (FACTORY/ BIGY FACTORY CNC HUB)  
 05 N° YC110-1101-06 (INT, ARRIÈRE/ INNER REAR) Ø16×21×74 (START/ PILOT/ BIGY 2016-2023)  
 05 N° YC110-1101-0601 (INT, ARRIÈRE/INNER REAR ) Ø17X24X74 (START/ PILOT/ BIGY 2025-26 INJECTED HUB)  
 05 N° YC110-1109-07 (INT, ARRIÈRE/INNER REAR ) Ø17X25X67 ( FACTORY/ BIGY FACTORY CNC HUB ) € 5

**ENTRETOISE SP3 2019 (TÉ 170 mm)**

WHEEL SPACER

- 04 N° YC110-0609-08 (AVANT DROITE/ FRONT RIGHT)  
 04 N° YC110-0610-08 (AVANT GAUCHE/ FRONT LEFT) € 7





# ↙ PNEUS TIRES



**CHAMBRE À AIR RENFORCÉE 4mm**  
REINFORCED TUBE 4mm

- 01 N° CHAMBRE10RENF (Ø 10" FRONT-REAR/ AV.-AR.) € 13
- 01 N° CHAMBRE12RENF (Ø 12" FRONT-REAR/ AV.-AR.) € 13
- 01 N° CHAMBRE14RENF (Ø 14" AV./ FRONT) € 13
- 01 N° CHAMBRE14ARRENF (Ø 14" AR./ REAR) € 16
- 01 N° CHAMBRE17RENF (Ø 17" AV./ FRONT) € 16

**CHAMBRE À AIR STANDARD**  
STANDARD TUBE

- 01 N° CHAMBRE10-2,5 (Ø 10" POUR/ FOR YCF 50) € 10
- 01 N° CHAMBRE12AV (Ø 12" AVANT/ FRONT) € 13
- 01 N° CHAMBRE16AR € 19
- 01 N° CHAMBRE17-02 (Ø 17" AV. AR./ FRONT-REAR) € 16
- 01 N° CHAMBRE19AV € 19

**FOND JANTE**  
TIRE LINING

- 02 N° YC110-11-01 (ROUE/ WHEEL 10/12")
- 02 N° YC110-06-01 (ROUE/ WHEEL 14")
- 02 N° YC110-06-02 (ROUE/ WHEEL 16")
- 02 N° YC110-06-07 (ROUE/ WHEEL 17")
- 02 N° YC110-06-08 (ROUE/ WHEEL 20") € 2



**BOUCHON DE VALVE CNC**  
**NOIR/ BLEU/ ROUGE/ VERT/ ORANGE/VIOLET**  
VALVE CAP SET  
BLACK/ BLUE/ RED/ GREEN/ ORANGE/ PURPLE

N° TVC-COLOR € 5



**PNEU AVANT CROSS 2,50/10**  
FRONT MX TIRE IN 2,50/10

N° 250/10 € 29



**PNEU AVANT CROSS EN 60/100/12**  
FRONT MX TIRE IN 60/100/12

N° 60/100/12 € 35



**PNEU ARRIÈRE CROSS EN 90/100/14**  
REAR MX TIRE IN 90/100/14

N° 90/100-14P398 € 59



**PNEU ARRIÈRE CROSS EN 3,00/10**  
REAR MX TIRE IN 3,00/10

N° 300/10 € 35



**PNEU ARRIÈRE CROSS EN 80/100/12**  
REAR MX TIRE IN 80/100/12

N° 300/12 € 35



**PNEU AVANT CROSS EN 70/100/17**  
FRONT MX TIRE IN 70/100/17

N° 70/100-17P397 € 45



**PNEU AVANT CROSS EN 60/100/14**  
FRONT MX TIRE IN 60/100/14

N° 60/100/14 € 35



**PNEU ARRIÈRE CROSS EN 90/100-16P52**  
REAR MX TIRE IN 90/100-16P52

N° 90/100-16P52 € 65



**PNEU AVANT CROSS EN 70/100-19P51**  
FRONT MX TIRE IN 70/100-19P51

N° 70/100-19P51 € 59



**PNEU 90/90/10**  
TIRE 90/90/10

N° 90/90/10 € 45

**KENDA**

10 12



**PNEU KENDA® SUPERMOTARD K702**

KENDA® SUPERMOTO TIRE K702

N° 90/90-10K702  
N° 100/90-10K702  
N° 110/70-12K702  
N° 120/70-12K702

€ 69  
€ 69  
€ 59  
€ 59

**ARRO™**

10



**PNEU ARRO® SPIDER CROSS EN 300/10**  
SPIDER ARRO® TIRE 300/10

N° 300/10 ARRO

€ 40

**ARRO™**

12



**PNEU ARRO® SPIDER CROSS AVANT EN 60/100/12**  
SPIDER ARRO® TIRE FRONT 60/100/12

N° 60/100/12 ARRO

€ 39

**ARRO™**

12



**PNEU ARRO® SPIDER CROSS ARR, EN 80/100/12**  
SPIDER ARRO® TIRE REAR 80/100/12

N° 80/100/12 ARRO

€ 55

**ARRO™**

14



**PNEU ARRO® SPIDER CROSS AVANT EN 60/100/14**  
SPIDER ARRO® TIRE FRONT 60/100/14

N° 60/100/14 ARRO

€ 49

**ARRO™**

12



**PNEU AVANT SUPERMOTARD ARRO®**  
FRONT SUPERMOTO TIRE ARRO®

N° 100/90-12

€ 45

**ARRO™**

12



**PNEU ARRIÈRE SUPERMOTARD ARRO®**  
REAR SUPERMOTO TIRE ARRO®

N° 120/80-12

€ 65

**GP**



**PAIRE DE COUVERTURE CHAUFFANTE AVEC BOITIER DE RÉGLAGE INDEPENDANT JUSQU'À 99 DEGRES**  
TIRE WARMERS WITH INDEPENDANT ADJUSTABLE TEMPERATURE CONTROL (UP TO 99 DEGREES)

N° YC110-1125-01-BK

€ 269

# REPOSE-PIEDS & SABOTS FOOT PEGS & SKID PLATES



**FACTORY**  
SPECIAL PARTS  
YCF RACING

**JEU DE REPOSE-PIED ALUMINIUM NOIR/ BLEU/ ROUGE/ VERT/ ORANGE/ VIOLET**  
ALUMINIUM FOOT PEGS BLACK/ BLUE/ RED/ GREEN/ ORANGE/ PURPLE

N° RPALU-COLOR

€ 69

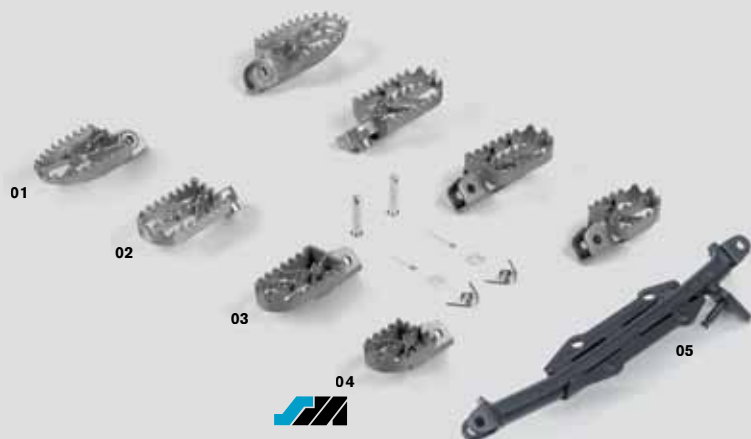

**JEU DE REPOSE-PIED**  
FOOT PEGS SET

- 01 N° YC110-0902/05 (INOX LARGE/ LARGE STAINLESS STEEL) € 49
- 02 N° YC110-0902/04 (INOX/ STAINLESS STEEL) € 49
- 03 N° YC110-0902/17 (ACIER/ STEEL) € 29
- 04 N° YC110-0902/06 (SUPERMOTO) € 29
- 05 N° YC110-0901-01 (GAMME START/ START RANGE) € 29



**SABOT RÉCUPÉRATEUR HUILE SUPERMOTARD EN FIBRE DE VERRE BLANC/ NOIR**  
RACE BELLY PAN WHITE/ BLACK

N° YC110-202-03-WH

€ 79

N° YC110-202-03-BK

€ 79

(Adaptable sur toute la gamme YCF/ fit on all YCF range)



**KIT COMPLET PROTECTION TEFLON SUPERMOTO**  
SUPERMOTO TEFLON PROTECTION SET

N° KS1

€ 59



**KIT PATIN TEFLON SUPERMOTO**  
SUPERMOTO TEFLON SET

N° KS4

€ 35



**RÉSERVOIR RÉCUPÉRATEUR DE LIQUIDE AVEC SEPARATEUR HUILE/ ESSENCE**  
CATCH CAN WITH SEPARATOR OIL/ GAZ

N° YC110-0816-02

€ 39



**KIT BOCAL RÉCUPÉRATEUR HUILE ET ESSENCE SUPERMOTO**  
SUPERMOTO OIL AND FUEL CATCH CAN

N° KS3

€ 29



**SABOT POUR FACTORY**  
SKID PLATE FOR FACTORY

N° YC110-207-12 (LITE/START/PILOT) (kickstart model)  
N° YC110-207-03 (FACTORY SP1)  
N° YC110-207-04 (FACTORY SP2)  
N° YC110-207-05 (FACTORY SP3) **€ 49**



**SÉLECTEUR ACIER REPLIABLE**  
FOLDABLE STEEL SHIFT LEVER

01 N° 24700/152FMH/04 LITE/ START 88SE/ START 125SE/ START 125/ PILOT 150E/ SUNDAY 124 (AVEC DÉPORT/ WITH EXT.)  
01 N° 24700/152FMH/02 (190 ZONGSHEN ENGINE)  
02 N° 24700/152FMH/03 PILOT 125/ FACTORY/ BIGY/ SM/ SUNDAY 157/ SUNDAY 187/ GP **€ 15**

**SÉLECTEUR ACIER REPLIABLE ET RÉGLABLE**  
FOLDABLE & ADJUSTABLE STEEL SHIFT LEVER

03 N° 24700-D LITE/ START 88SE/ START 125SE/ START 125/ PILOT 150E/ SUNDAY 124 (AVEC DÉPORT/ WITH EXT.)  
04 N° 24700-SD PILOT 125/ FACTORY/ BIGY/ SM/ SUNDAY 157/ SUNDAY 187/ GP **€ 19**

## ↙ SÉLECTEURS SHIFT LEVERS



**SÉLECTEUR ALUMINIUM CNC AVEC DÉPORT POUR AXE SÉLECTEUR COURT**  
NOIR/ BLEU/ ROUGE/ ORANGE/ VERT/ VIOLET  
ALUMINUM CNC GEAR LEVER WITH EXTENSION FOR SHORT LEVER SHAFT  
BLACK/ BLUE/ RED/ ORANGE/ GREEN/ PURPLE

01 N° STMD-COLOR LITE/ START 88SE / START 125SE/ START 125/ PILOT 150E/ SUNDAY 124 **€ 39**

**SÉLECTEUR FORGÉ NOIR/ BLEU/ ROUGE/ ORANGE/ VERT/ VIOLET**  
FORGED GEARSHIFT BLACK/ BLUE/ RED/ ORANGE/ GREEN/ PURPLE

02 N° 24700-01-COLOR PILOT 125/ FACTORY/ BIGY/ SM/ SUNDAY 157/ SUNDAY 187/ GP **€ 39**



**KICK ACIER ORIGINE**  
ORIGINAL STEEL KICKSTARTER

01 N° 43451/152FMH (Ø 13mm)  
02 N° 43452/152FMH (Ø 16mm) **€ 19**

**KICK ACIER RENFORCÉ**  
REINFORCED KICKSTARTER

02 N° YC140-27500SI (Ø 13mm)  
02 N° YC140-27600SI (Ø 16mm) **€ 49**

**RESSORT/ BILLE/ VIS POUR KICK**  
BALL, SPRING, AND SCREW FOR KICKSTARTER

03 N° KVK **€ 4**



**KICK YCF ALUMINIUM 2026**  
YCF KICKSTARTER ALUMINIUM 2026

01 N° YC140-27400-01 (13mm) **€ 49**  
02 N° YC140-27400-02 (16mm) **€ 49**

# KIT CHAÎNE & TRANSMISSION

## SPROCKET KITS & TRANSMISSIONS

SPECIAL PARTS  
YCF RACING



41 45

**COURONNE ACIER Ø INTÉRIEUR 75 - ENTRAXE COURONNE 92 - 5 TROUS DE FIXATION POUR FACTORY 2016-26**

STEEL SPROCKET INNER Ø 75 - SPROCKET CENTER TO CENTER DISTANCE 92 - 5 HOLES FIXATION FOR FACTORY 2016-26

N° YC110-11-062/41 (41 DENTS/ TEETH)  
N° YC110-11-062/45 (45 DENTS/ TEETH)

€ 19

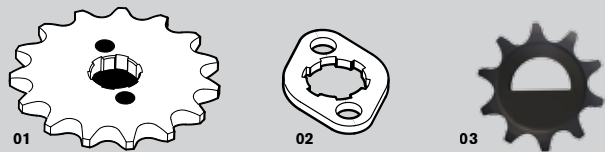

**PIGNON SORTIE BOÎTE & PLAQUE PIGNON**  
COUNTERSHAFT SPROCKET & SPROCKET PLATE

01 N° 22711/152FMI14 (Ø 20 PIGNON 14 DENTS/ SPROCKET 14 TEETH) € 9  
01 N° 22711/152FMI15 (Ø 20 PIGNON 15 DENTS/ SPROCKET 15 TEETH) € 9  
02 N° 22712/152FMH (Ø 17 PLAQUE PIGNON/ SPROCKET PLATE) € 6  
02 N° 22712/152FMI (Ø 20 PLAQUE PIGNON/ SPROCKET PLATE) € 6  
03 N° RS35/10T (PIGNON 10 DENTS/ SPROCKET 10 TEETH) YCF 50E € 49  
03 N° RS35-10T-01 (PIGNON 10 DENTS/ SPROCKET 10 TEETH) W88 2020-21 € 49  
03 N° 420H-11T-06 (PIGNON 420 11 DENTS / SPROCKET 11 TEETH 420) W88 2022-26 € 39

SPECIAL PARTS  
YCF RACING



**CHAÎNE RENFORCÉE 420 116 MAILLONS BLEUE/ ROUGE/ VERTE/ JAUNE/ ORANGE**  
REINFORCED CHAIN 420 116 LINKS BLUE/ RED/ GREEN/ YELLOW/ ORANGE

N° 420-116T-COLOR

€ 25

SPECIAL PARTS  
YCF RACING

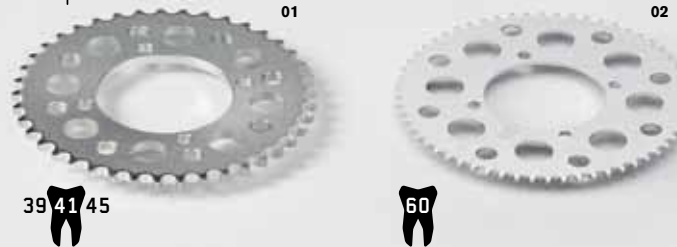

39 41 45

60

**COURONNE ACIER Ø INTÉRIEUR 75 - ENTRAXE COURONNE 92**

STEEL SPROCKET INNER Ø 75 - SPROCKET CENTER TO CENTER DISTANCE 92

01 N° YC110-11-06/39 (39 DENTS/ TEETH) € 19  
01 N° YC110-11-06/41 (41 DENTS/ TEETH) € 19  
01 N° YC110-11-06/45 (45 DENTS/ TEETH) € 19  
02 N° YC110-11-05/60 (60 DENTS/ TEETH - YCF 50E/ W88) € 29

SPECIAL PARTS  
YCF RACING



**PIGNON SORTIE BOÎTE ANTI BOUE Ø 17**  
ANTI MUD COUNTERSHAFT SPROCKET Ø 17

N° 22711/152FMZ13 (13 DENTS/ TEETH) € 9  
N° 22711/152FMZ14 (14 DENTS/ TEETH) € 9  
N° 22711/152FMZ15 (15 DENTS/ TEETH) € 9  
N° 22711/152FMZ16 (16 DENTS/ TEETH) € 9  
N° 22711/152FMZ17 (17 DENTS/ TEETH) € 9  
N° 22711/152FMZ18 (18 DENTS/ TEETH) € 9  
N° 420H/10T (10 DENTS/ TEETH) (YCF 50A) € 10

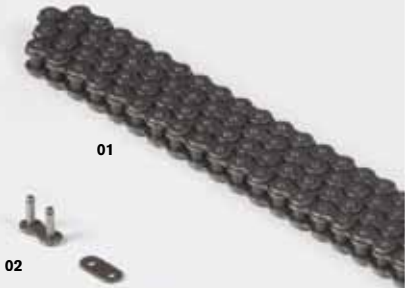

**CHAÎNE 420 ET RS35**  
CHAIN 420 AND RS35

01 N° 420H-104T (104 MAILLONS/ LINKS) € 17  
01 N° 420H-110T (110 MAILLONS/ LINKS) € 17  
01 N° 420H-116T (116 MAILLONS/ LINKS BIGY) € 17  
01 N° 420DX-120T (120 MAILLONS/ LINKS BIGY 16-19) € 35  
01 N° RS35-114T (114 MAILLONS/ LINKS 50E) € 19

**ATTACHE RAPIDE**  
CHAIN JOINING LINK

02 N° AR-420 € 3  
02 N° AR-35 (YCF 50E) € 3



32 34 35 36 37 39 40 41 42 43 45 47



**COURONNE ALU. TAILLÉE DANS LA MASSE DISPONIBLE EN 32, 34, 35, 36, 37, 39, 40, 41, 42, 43, 45, 47 DENTS NOIRE/ BLEUE/ ROUGE/ VERTE/ ORANGE Ø INTÉRIEUR 75 - ENTRAXE COURONNE 92**

BILLET ALUMINUM SPROCKET AVAILABLE IN 32, 34, 35, 36, 37, 39, 40, 41, 42, 43, 45, 47 TEETH BLACK/ BLUE/ RED/ GREEN/ ORANGE INNER Ø 75 - SPROCKET CENTER TO CENTER DISTANCE 92

N° CA06R+TEETH-COLOR  
(YCF50A - LITE - START - PILOT - SM)

€ 39

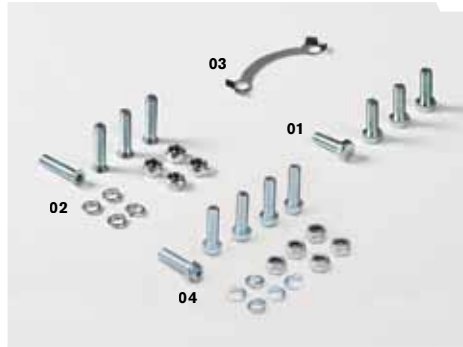

**KIT VIS COURONNE**  
SCREW SET FOR SPROCKET

01 N° KVC € 5  
02 N° KVC-1 (TÊTE FRAISÉE/ FLAT HEAD) € 5  
04 N° KVC-2 (KIT VIS PLATES/ SCREW KIT FLAT HEAD) € 6

**BLOC COURONNE**  
BLOCK SPROCKET

03 N° YC110-11-03

€ 5



**TENDEUR CHAÎNE CNC NOIR/ BLEU/ ROUGE/ VERT/ ORANGE/ VIOLET**  
CNC AXLE BLOCK BLACK/ BLUE/ RED/ GREEN/ ORANGE/ PURPLE

01 N° TC07-COLOR (Ø 15) (POUR BRAS ACIER/ FOR STEEL SWING ARM) (START/ PILOT)  
02 N° TC12-COLOR (POUR BRAS ALU/ FOR ALU SWING ARM - 2011-2026) (FACTORY/ BIGY) € 19



41 43 45 47



**COURONNE ALU, TAILLÉE DANS LA MASSE - 5 TROUS DE FIXATION POUR FACTORY 2016-2026 - DISPONIBLE EN 41, 43, 45, 47 DENTS NOIRE/ BLEUE/ ROUGE/ VERTE/ ORANGE - Ø INTÉRIEUR 75 - ENTRAXE COURONNE 92**

BILLET ALUMINUM SPROCKET - 5 HOLE FIXATION FOR FACTORY 2016-2026 - AVAILABLE IN 41, 43, 45, 47 TEETH BLACK/ BLUE/ RED/ GREEN/ ORANGE - INNER Ø 75 - SPROCKET CENTER TO CENTER DISTANCE 92

N° CA16R+TEETH-COLOR  
(FACTORY-BIGY)

€ 39



**PROTECTION PIGNON SORTIE BOÎTE (VIS & ENTRETOISES INCLUSES)**  
COUNTERSHAFT SPROCKET GUARD (SCREWS & SPACERS INCLUDED)

01 N° YC110-1803-BK (ELECTRIC START ENGINE) (START SE 88/ START SE 125/ PILOT 150 E/ BIGY 150 FACTORY E) € 19  
02 N° YC110-1803-02-BK (LITE /START 125/PILOT 125/BIGY125-150/BIGY190 DAYTONA) € 15



**CLÉ À BOUGIE**  
SPARK PLUG REMOVAL TOOL

01 N° CB € 6

**ARRACHE VOLANT 3 EN 1**  
**ADAPTABLE SUR TOUS LES MOTEURS DE MINI**  
FLYWHEEL REMOVER 3 IN 1  
SUITABLE FOR ALL MINI BIKES ENGINES

02 N° ARRACHE-1 € 15

**OUTIL POUR DÉMONTER NOIX EMBRAYAGE ET ÉPURATEUR**  
CLUTCH TOOL

03 N° OUTIL € 15

**DÉRIVE CHAÎNE PROFESSIONNEL**  
PROFESSIONAL CHAIN TOOL

04 N° DERIVE-1 € 25

**CLÉ À RAYONS**  
SPROKE WRENCH

05 N° CLEARAYON-02 € 7

**JEU DE CALES MOTEUR**  
ENGINE FEELER GAUGES

06 N° JCM-1 € 7

**DÉMONTE PNEU EN CUILLÈRE**  
SPOON TIRE LEVER

07 N° DEMONT-1 € 12

**OUTIL RÉGLAGE SOUPAPES**  
VALVE ADJUSTMENT TOOL/ WRENCH

10 N° YC110-2410-01 € 9

**FREIN FILET - ROUGE : FORT / BLEU : MOYEN**  
THREADLOCKER - RED: STRONG / BLUE: MEDIUM

08 N° FF271 (STRONG/ FORT)  
09 N° FF242 (MEDIUM/ MOYEN) € 16





**KIT DÉPART ENGI®**  
ENGI® LAUNCH CONTROL

N° ENGIHKF-BK

€ 59



**BAGUE/ JOINT SPI/ CACHE POUSSIÈRE FOURCHE**  
FORK RING/ OIL SEAL/ DUST COVER

- 01 N° EF03-0027-BC (INFÉRIEURE/ LOWER) € 12
  - 02 N° EF03-0005 (SUPÉRIEURE/ UPPER) € 12
  - 03 N° EF03-0009-01 (ENGI®) € 9
  - 04 N° EF03-0011-01 (ENGI®) € 12
- (VENDU À L'UNITÉ/ SELL BY UNIT)



**FOURCHE ENGI® RÉGLABLE COMPRESSION DÉTENTE AVEC CORPS ALUMINIUM ET TRAITEMENT DU TUBE INF.**  
ENGI® FORK WITH ADJUSTABLE COMPRESSION & REBOUND

N° ENGI2-800-GY (800mm)

€ 649



**FOURCHE ENGI® RÉGLABLE COMPRESSION DÉTENTE**  
ENGI® FORK WITH ADJUSTABLE COMPRESSION & REBOUND

N° ENGI2-735-GY (735mm)

€ 599

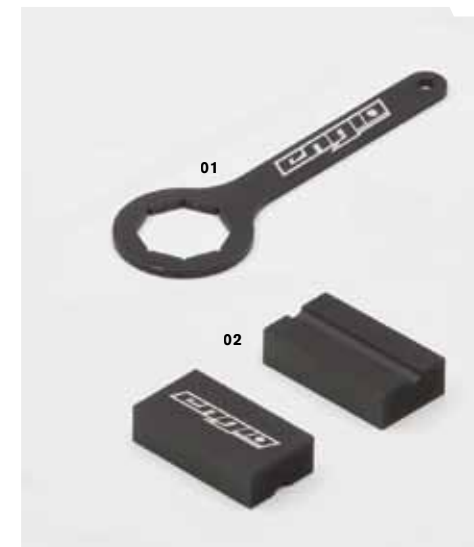

**OUTIL DÉMONTAGE BOUCHON (du haut) ENGI®**  
ENGI® PLUG REMOVAL TOOL

01 N° ENGI-FCW

€ 49

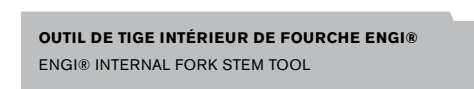

**OUTIL DE TIGE INTÉRIEUR DE FOURCHE ENGI®**  
ENGI® INTERNAL FORK STEM TOOL

02 N° ENGI-DAT

€ 49





**AMORTISSEUR ENGI® RÉGLABLE DÉTENTE**  
ENGI® SHOCK ABSORBER ADJUSTABLE REBOUND

- |  |              |
|--|--------------|
| N° YC110-0404-66 (310mm PILOT 2013-19/ SM 2013-26) | <b>€ 269</b> |
| N° YC110-0404-61 (330mm SP2/ PILOT 20-26)          | <b>€ 269</b> |
| N° YC110-0404-63 (335mm SP3)                       | <b>€ 269</b> |
| N° YC110-0404-69 (355mm BIGY)                      | <b>€ 269</b> |



**KIT RÉFECTION INTERIEUR AMORTISSEUR**  
ENGI® SHOCK INTERNAL REPAIR KIT

N° ES01-000B

**€ 59**



**KIT RÉFECTION ENTRETOISE AXE AMORTISSEUR**  
ENGI® SHOCK SPACER KIT

N° ES01-000C

**€ 25**

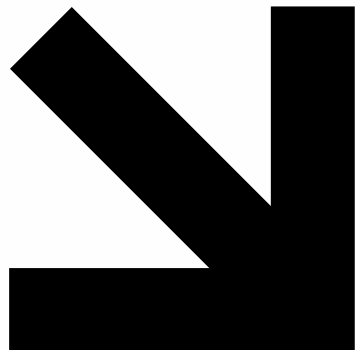
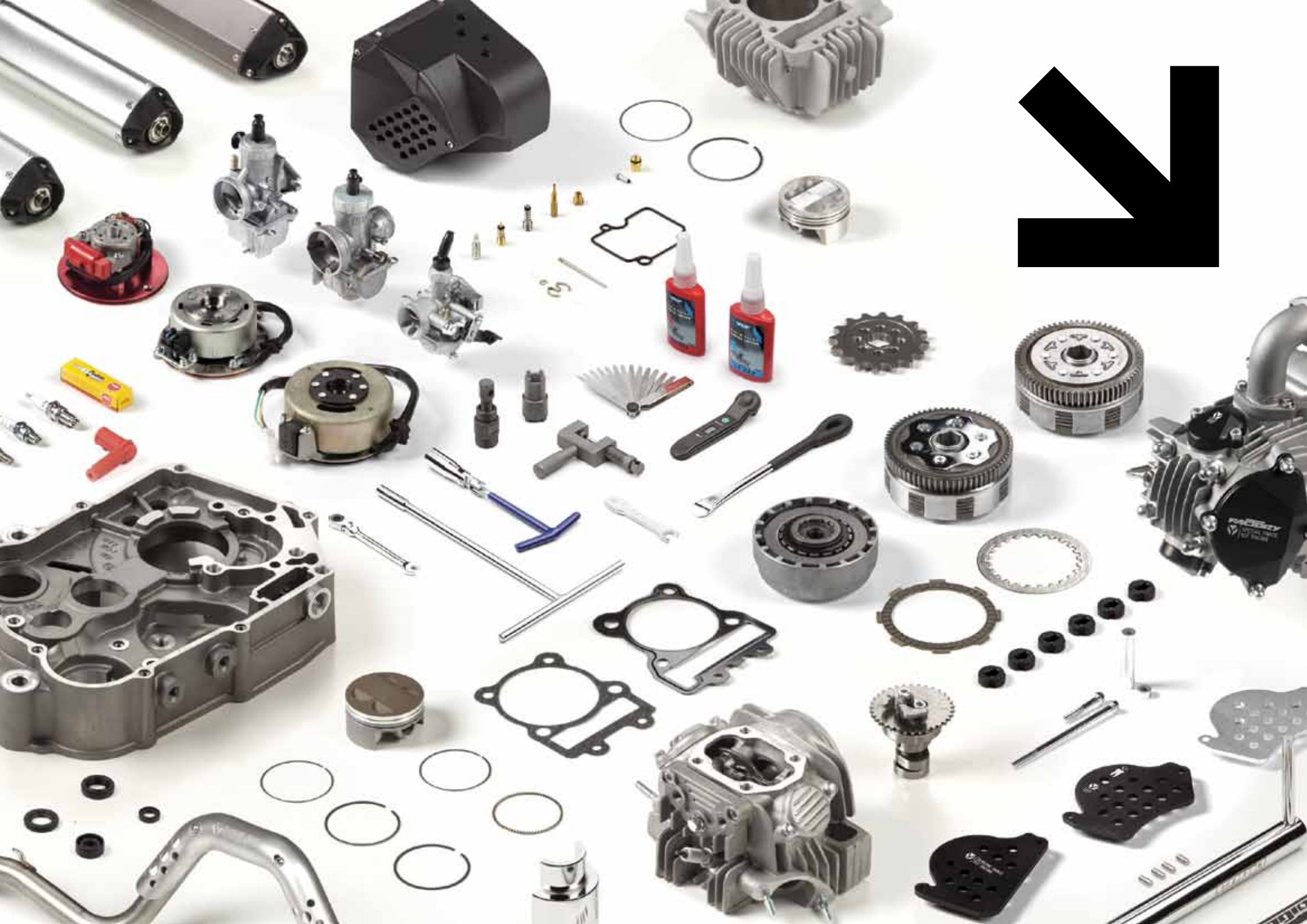

# ENGINE PARTS

## PIÈCES MOTEUR

<b>MOTEURS DAYTONA®/ DAYTONA® ENGINES</b>	124
<b>MOTEURS/ ENGINES</b>	124
<b>KITS MOTEUR/ ENGINE KITS</b>	126
<b>EMBAYAGE/ CLUTCH</b>	129
<b>CARBURATEURS/ CARBURETORS</b>	131
<b>FILTRES À AIR/ AIR FILTERS</b>	133
<b>ÉCHAPPEMENTS/ EXHAUSTS</b>	134
<b>FILTRES &amp; RADIATEURS/ FILTERS &amp; COOLERS</b>	137
<b>ALLUMAGE/ IGNITION</b>	138
<b>HUILE YCF/ YCF LUB</b>	140
<b>PIÈCES RACING DAYTONA®/ DAYTONA® RACING PARTS</b>	142
<b>PIÈCES D'ORIGINE DAYTONA®/ DAYTONA® PARTS</b>	143



# MOTEURS ENGINES

# DAYTONA®

DAYTONA® EST UNE SOCIÉTÉ JAPONNAISE SPÉCIALISÉE DANS LE DÉVELOPPEMENT ET LA FABRICATION DE PIÈCES HAUTE PERFORMANCE MOTOS DEPUIS 1972. L'ENTREPRISE EST UN LEADER INTERNATIONAL DE L'INDUSTRIE DES PIÈCES RACING.  
(DÉTAIL DES PIÈCES À PARTIR DE LA PAGE 130)

DAYTONA® IS A JAPANESE COMPANY SPECIALIZING IN HIGH PERFORMANCE MOTORCYCLE PARTS. THEY HAVE BEEN A LEADER IN THE MOTORCYCLE INDUSTRY SINCE 1972. DAYTONA PROVIDES MOTORCYCLE RACING PARTS, AS WELL AS OE MOTORCYCLE PARTS, TO THE ENTIRE INTERNATIONAL MARKETPLACE. (SEE PARTS DETAILS STARTING ON PAGE 130)

**CARTER RENFORCÉ**  
REINFORCED CRANKCASE



FEATURING

**DÉCOMPRESSEUR AUTOMATIQUE**  
DECOMPRESSION SYSTEM



DAYTONA



## ANIMA® 2.0 MX

**MOTEURS DAYTONA® ANIMA® 2,0**  
DAYTONA® ANIMA® 2.0 ENGINES

N° 88025 (ANIMA® 160cc, FSM, 4 SPEEDS)  
N° 81244 (190cc, SYS, 4 SPEEDS)

€ 1199  
€ 1249



**MOTEUR DAYTONA® 190cc FE DÉMARREUR ÉLECTRIQUE 5 VITESSES**  
DAYTONA® 190cc FE ENGINE ELECTRIC START 5 SPEEDS

N° 88392

€ 1149

# ZONGSHEN



**MOTEUR ZONGSHEN® FIDDY**  
ZONGSHEN® FIDDY ENGINE

01 N° MOTEUR110-G  
01 N° MOTEUR125-G  
02 N° MOTEUR155-G

€ 499  
€ 549  
€ 749

**MOTEUR 50 YCF 2012-2020 AUTOMATIQUE**  
YCF 50 ENGINE 2012-2020 AUTOMATIC

01 N° MOTEUR50-01-GY € 429

**MOTEUR 88 4 VITESSES SEMI-AUTOMATIQUE**  
88 4 SPEED SEMI-AUTOMATIC ENGINE

02 N° MOTEUR88 € 399

**MOTEUR 88 À DÉMARREUR**  
88 4 SPEED SEMI-AUTOMATIC ENGINE ELECTRIC START

03 N° MOTEUR88ELE-02-ZF € 449

**MOTEUR 110 AUTOMATIQUE À DÉMARREUR**  
110 ENGINE AUTOMATIC ELECTRIC START

04 N° MOTEUR110ZS-SE-AUTOMATIC € 399

**MOTEUR 125 4 VITESSES SEMI-AUTOMATIQUE**  
125 4 SPEED SEMI-AUTOMATIC ENGINE

05 N° MOTEUR125SEMI € 429

**MOTEUR 125 À DÉMARREUR**  
125 4 SPEED SEMI-AUTOMATIC ENGINE ELECTRIC START

06 N° MOTEUR125SELE-ZF € 499

**MOTEUR 125 POINT MORT**  
125 NEUTRAL ENGINE

07 N° MOTEUR125P € 399

**MOTEUR 150-3**  
150-3 ENGINE

08 N° MOTEUR150-3 € 579

**MOTEUR 150 TYPE CRF**  
150 ENGINE TYPE CRF

09 N° MOTEUR150-5 € 679

**MOTEUR 150 YX DÉMARREUR ÉLECTRIQUE**  
150 YX ENGINE ELECTRIC START

10 N° MOTEUR150-3E € 599

**MOTEUR150-2E DÉMARREUR ÉLECTRIQUE TYPE KLX**  
150-2E ENGINE ELECTRIC START KLX TYPE

11 N° MOTEUR150-2E € 849

**MOTEUR 150 TYPE KLX**  
150 ENGINE TYPE KLX

12 N° MOTEUR150-2 € 749



01



02



06



03



07



04



08



10



05



09



12



11



# **KITS MOTEUR & PIÈCES** **ENGINE KITS & PARTS**



**CHAÎNE DE DISTRIBUTION**  
TIMING SPROCKET

N° D00F012 (84 MAILLONS POUR 125cc POINT MORT ET SEMI-AUTOMATIQUE/ 84 LINKS FOR 125cc NEUTRAL START AND SEMI-AUTOMATIC) **€ 25**  
 N° 14350/152FMI (90 MAILLONS POUR 125/ 140/ 150 CRF/ 90 LINKS FOR 125/ 140/ 150 CRF TYPE) **€ 25**  
 N° 210F012 (POUR YX 150/ 160 TYPE KLX/ FOR 150/ 160 YX KLX TYPE) **€ 39**



**BOUCHON CARTER ALUMAGE YCF CNC**  
**NOIR/ BLEU/ ROUGE/ VERT/ ORANGE/ VIOLET**  
ALUMINIUM CAP BIG VIEW HOLE FOR YCF COVER  
BLACK/ BLUE/ RED/ GREEN/ ORANGE/ PURPLE

N° YC110-2014-01+COLOR

**€ 9**



**CARTER D'ALLUMAGE POUR DÉMARREUR ÉLECTRIQUE**  
IGNITION COVER ELECTRIC START

01 N° 12301-D083-000189  
02 N° 90204-D083-000

**€ 39**  
**€ 4**



**NOUVEAU CARTER D'ALLUMAGE YCF (Pour démarrage au kick)**  
NEW YCF IGNITION COVER (kickstart only)

01 N° YC110-2004-01-GY (GRIS/GREY)  
02 N° YC110-2004-01-BK (NOIR/BLACK)  
03 N° YC110-2004-01-MG (MAGNESIUM)

**€ 49**  
**€ 49**  
**€ 49**

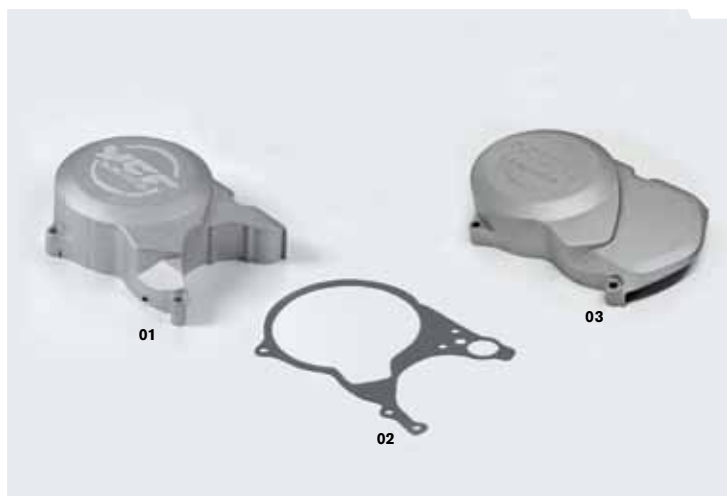

**CARTER D'ALLUMAGE**  
IGNITION COVER

- 01 N° 11411/152FMH (CARTER D'ALLUMAGE/ IGNITION COVER) € 39
- 02 N° 11419/152FMH (JOINT CARTER ALLUMAGE/ IGNITION COVER GASKET) € 7
- 03 N° A00-8-1(CARTER ALLUMAGE LITE 88/125) € 39

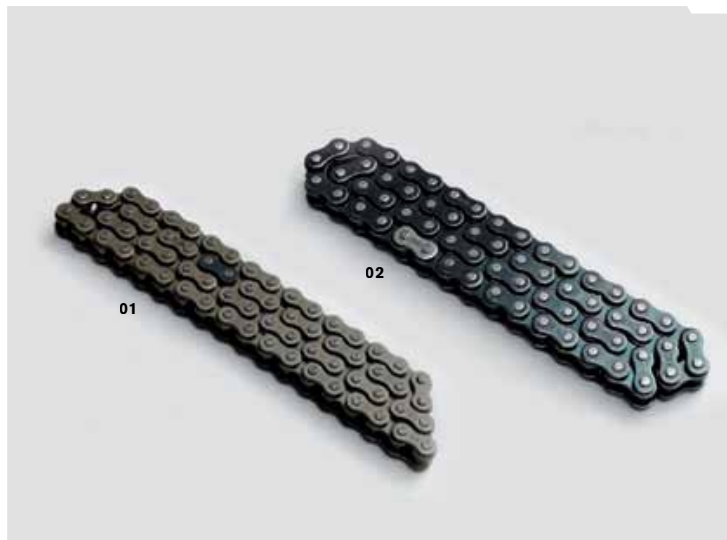

**CHAÎNE DE DÉMARREUR**  
STARTER CHAIN

- 01 N° 2141B-IA29-0000 POUR MOTEUR/ FOR ENGINE 88-125 SE € 12
- 02 N° 100061493 POUR MOTEUR/ FOR ENGINE 190 ZONGSHEN® € 19



**KIT PISTON**  
PISTON KIT

- N° KPC/39-13 (YCF 50) € 55
- N° KPC/44-13 (YCF 50A 2012-24) € 55
- N° KPC/47-13 (88 CC Ø 46,5 AXE 13) € 55
- N° KPC/52,5-13 (88/107/120/125 CC Ø 52,5 AXE 13) € 55
- N° KPC/54-13ZS (110/125 ZONGSHEN FIDDY) € 55
- N° KPC/52,5-14 (120/125 CC Ø 52,5 AXE 14) € 55
- N° KPC/54-14 (120/125 CC Ø 54 AXE 14) € 55
- N° KPC/56-13 (140/150 YX TYPE CRF Ø 56 AXE 13) € 55
- N° KPC/60-13 (150-160 YX TYPE KLX Ø 60 AXE 13) € 59
- N° KPC/60-13ZS (155 ZONGSHEN) € 59

**JEU DE SEGMENTS SEUL**  
PISTON RINGS SET ONLY

- N° 13300F (88 CC Ø 46,5) € 20
- N° 13300/152FMI (107-125 CC Ø 52,5) € 20
- N° 13300/152FMH (125-138 CC Ø 54) € 20
- N° 13300 (140 CC Ø 55) € 20
- N° 208J013 (140-150 CC Ø 56) € 20
- N° 210J013 (150 CC Ø 60) € 20

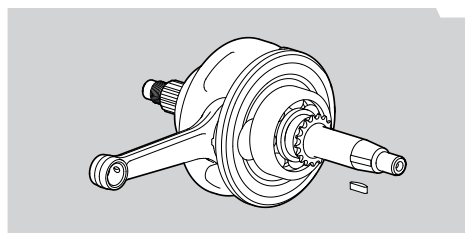

**VILEBREQUIN**  
CRANKSHAFT

- N° 208J000 (125/140 YX AXE PISTON 13) € 119
- N° 216J000 (150 CRFAXE PISTON 13) € 139
- N° 2104J000 (150 KLX) € 139
- N° 2043J000 (125 POINT MORT) € 119





**CYLINDRES & CULASSES COMPLÈTES**  
CYLINDERS & CYLINDER HEADS

- 01 N° 206A038 (125 YX 52,5mm) € 99
- 01 N° 2081A038 (140 YX 56mm) € 99
- 01 N° 208A038 (150 YX TYPE CRF) € 99
- 01 N° 210A038 (150 YX TYPE KLX) € 119
- 01 N° 204A038 (125 YX 54mm) € 99
  
- 02 N° 206A000 (125 YX) € 199
- 02 N° 208A000 (140/150 YX TYPE CRF) € 199
- 02 N° 210A000 (150/160 YX TYPE KLX) € 209

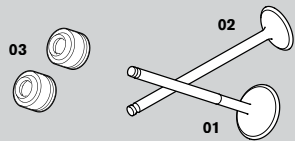

**SOUPAPE D'ADMISSION**  
INLET VALVE

- 01 N° 206F045 (125 YX Ø 24)
  - 01 N° 14710/152FMI (125, 140, 150 Ø 27)
  - 01 N° 210F045 (KLX)
- € 19**

**SOUPAPE D'ÉCHAPEMENT**  
EXHAUST VALVE

- 02 N° 206F039 (125 YX Ø 21)
  - 02 N° 14720/152FMI (125, 140, 150 Ø 23)
  - 02 N° 210F039 (KLX 4V)
- € 19**

**JOINT QUEUE SOUPAPE**  
VALVE STEM SEAL

- 03 N° 14730/152FMH
- € 5**

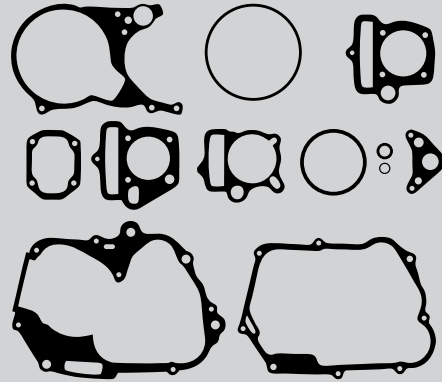

**POCHETTE JOINTS COMPLÈTE**  
COMPLETE GASKET SET

- N° PJCM50 (50S YCF 2010-2011) € 39
- N° PJCM50-2 (50A YCF 2012-2026) € 39
- N° PJCM88 (88 CC) € 39
- N° PJCMSE (START F88SE/ F125SE) € 39
- N° PJCM125 (125 CC) € 39
- N° PJCM125-G (110/125 ZONGSHEN FIDDY) € 39
- N° PJCM140 (140 CC) € 39
- N° PJCM150CRF (150 CC) € 39
- N° PJCM150KLX (150 CC TYPE KLX) € 39
- N° PJCM150-3E (PILOT F150E 2022-26) € 39
- N° PJCM155-G (155 ZONGSHEN) € 39



**POCHETTE JOINTS HAUT MOTEUR**  
GASKET SET TOP END

- N° PJHM50 (50S YCF 2010-2011) € 20
- N° PJHM50-2 (50A YCF 2012-2026) € 20
- N° PJHM88 (88 CC) € 20
- N° PJHM125 (125 CC) € 20
- N° PJHM125-G (110/125 ZONGSHEN FIDDY) € 20
- N° PJHM140 (140 CC) € 20
- N° PJHM150CRF (150 CC) € 20
- N° PJHM150KLX (150 CC TYPE KLX) € 20
- N° PJHM150-3E (PILOT F150E 2022-26) € 20
- N° PJHM155-G (155 ZONGSHEN) € 20

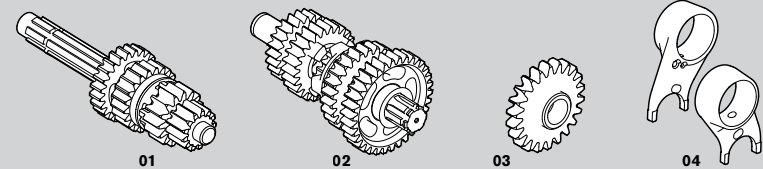

**ARBRE BOÎTE PRIMAIRE COMPLET Ø 12 CÔTÉ ALLUMAGE Ø 14 CÔTÉ EMBR. LIFAN LONG. 155mm/ YX LONG. 153,5mm**  
COMPLETE MAIN BOX SHAFT Ø 12 IGNITION SIDE & Ø 14 CLUTCH SIDE LIFAN LENGTH 155mm/ YX LENGTH 153,5mm

- 01 N° E13K030 (YX)
  - 01 N° A00K030 (88/ 125 SEMI-AUTO ET 125 POINT MORT)
- € 49**

**ARBRE BOÎTE SECONDAIRE COMPLET Ø 17 CÔTÉ PSB LIFAN Ø 14 CÔTÉ ALLUMAGE/ YX Ø 15 CÔTÉ ALLUMAGE**  
COMPLETE SECONDARY BOX SHAFT Ø 17 PSB SIDE LIFAN Ø 14 IGNITION SIDE/ YX Ø 15 IGNITION SIDE

- 02 N° E13K040 (YX)
  - 01 N° A00K040 (88/ 125 SEMI-AUTO ET 125 POINT MORT)
- € 49**

**PIGNON INTERMÉDIAIRE EMBRAYAGE**  
INTERMEDIATE CLUTCH SPROCKET

- 03 N° 208-12-23N (YX : ÉPAISSEUR/ THICKNESS 14mm)
- € 12**

**JEU DE FOURCHETTES DE BOÎTE RENFORCÉE**  
REINFORCED GEARBOX FORK

- 04 N° FBR
- € 35**

# EMBRAYAGE CLUTCH



**EMBRAYAGE COMPLET DÉMARRAGE AU POINT MORT  
START 2012-26**  
COMPLETE CLUTCH NEUTRAL START  
START 2012-26

N° EC

€ 65



**EMBRAYAGE COMPLET 88/125 SEMI-AUTO**  
COMPLETE CLUTCH 88/125 SEMI-AUTO

N° 21100L

€ 79



**EMBRAYAGE COMPLET POUR DÉMARRAGE EN PRISE**  
COMPLETE CLUTCH FOR KICKSTARTER ENGINE

N° 22100/152FMH  
N° 100103297 (Zongshen fiddy racer 110/125)  
N° 22000-JZ28-0000 (Zongshen 155)

€ 79  
€ 79  
€ 79



**COURONNE D'EMBRAYAGE 88/125 SEMI-AUTO**  
CLUTCH SPROCKET 88/125 SEMI-AUTO

N° 22610L - 69 TEETH (START SE 88/125)  
N° A00K016 - 67 TEETH (LITE 88-125/ START 125)

€ 25  
€ 25



**DISQUE D'EMBRAYAGE YX**  
YX CLUTCH PLATE

01 N° 22330/152FMH (GARNI/ FRICTION)  
02 N° 22341/152FMH (LISSE/ SMOOTH)

€ 6  
€ 6



**DEMI CARTER EMBRAYAGE 88/ 125**  
HALF CLUTCH COVER 88/ 125

N° RCSC-BK

€ 25



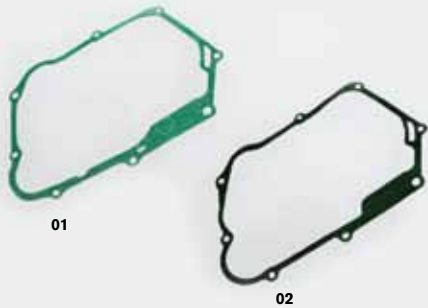

**JOINTS DE CARTER D'EMBRAYAGE**  
ENGINE CLUTCH COVER GASKET

01 N° E041B002 (START/ PILOT 125) € 9  
02 N° 11319/152FHM (125 - 140 - 150CRF) € 9



**JOINT SPY SÉLECTEUR**  
OIL SEAL SHAFT

01 N° 24190/152FHM € 7

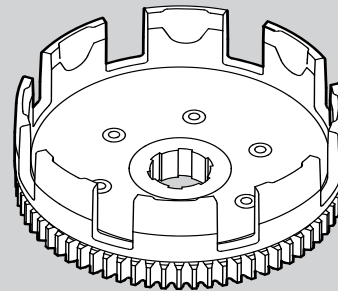

**CLOCHE D'EMBRAYAGE**  
CLUTCH BELL

N° 22110/152FHM € 49

**PIGNON DE KICK**  
KICKSTARTER SPROCKET YX

02 N° 208K025 (YX) € 15

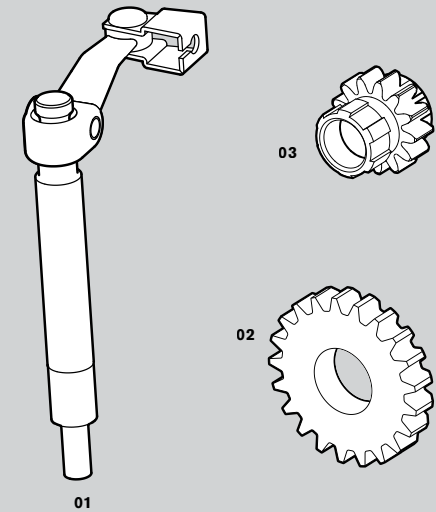

**PIGNON CLOCHE EMBRAYAGE**  
CLUTCH BELL SPROCKET

03 N° 208-12-25 (YX) € 15

**TIGE COMMANDE EMBRAYAGE**  
PUSH ROD

01 N° 22810/152FHM € 15



**ARBRE À CAME RACING POUR MOTEUR 140/150 YX**  
(PILOT/BIGY 150)

RACING CAMSHAFT FOR YX 140/150 ENGINE  
(PILOT/BIGY 150)

N° Z40 € 69

**JOINT SPY KICK**  
KICKSTARTER OIL SEAL

02 N° F001C015 (KLX: 16X28X7)  
02 N° F05C085 (CRF: 16X24X5)  
02 N° 27190/152FHM (Ø 13mm) € 6

**JOINT SPY PSB**  
OIL SEAL FOR COUNTERSHAFT SPROCKET

03 N° 23790/152FMI (Ø 20 - 20/30/4.5)  
03 N° 23790/152FMH (Ø 17 - 17/29/5) € 6

**JOINT SPY TIGE COMMANDE EMBRAYAGE**  
CLUTCH CONTROL OIL SEAL

04 N° 22840/152FMH € 5



# CARBURATEURS CARBURETORS



## CARBURATEUR NIBBI

NIBBI CARBURETOR

01 N° YC50-20-31 POUR MOTEUR 50cc	€ 59
02 PZ18FL POUR MOTEUR 88cc	€ 69
03 N° PE19FL POUR MOTEUR 125/150cc N° PE24SP-FL (SM125/SM150)	€ 75 € 79
04 N° PE28SP POUR MOTEUR 190cc	€ 99
05 N° NIBBI34	€ 169

**GICLEUR NIBBI CARBURATEUR PE GICLEUR PRINCIPAL / MAIN JET 88/90/92/95/98/100/102/105/108/110/112/115/118/120/122/125/128/130/132/135**

06 N° LK-PE+TAILLE/SIZE	€ 7
-------------------------	-----

**GICLEUR NIBBI CARBURATEUR PWK GICLEUR PRINCIPAL / MAIN JET 98/100/102/105/108/110/112/115/118/120/122/125/128/130/132/135/138/140/142/145/148**

07 N° LK-PWK+TAILLE/SIZE	€ 7
--------------------------	-----

**GICLEUR NIBBI CARBURATEUR PZ GICLEUR PRINCIPAL / MAIN JET 70/72/78/80/82/85/90/95/100**

08 N° LK-PZ+TAILLE/SIZE	€ 7
-------------------------	-----

**GICLEUR NIBBI CARBURATEUR PE/PWK GICLEUR RALENTI / SLOW JET 32/35/38/42/45/48/56**

09 N° LK-FLK+TAILLE/SIZE	€ 7
--------------------------	-----

**GICLEUR NIBBI CARBURATEUR PZ GICLEUR RALENTI / SLOW JET 32/35/38**

10 N° LK-FLKZ+TAILLE/SIZE	€ 7
---------------------------	-----



## KIT CARBURATEUR NIBBI 24

KIT CARBURETOR NIBBI 24

N° NIBBI24	€ 119
------------	-------



## CARBURATEUR KEIHIN® PE28mm

PE28mm KEIHIN® CARBURETOR

N° 85707	€ 239
----------	-------



## VIS DE CUVE MIKUNI®

MIKUNI® TANK SCREW

01 N° 16007L	€ 7
--------------	-----

## VIS RICHESSE + RESSORT MIKUNI®

MIKUNI® NEEDLE VALVE + SPRING

02 N° 16005L	€ 7
--------------	-----

## VIS RALENTI + RESSORT MIKUNI®

MIKUNI® IDLE SCREW + SPRING

03 N° 16006L	€ 7
--------------	-----

## GICLEUR RALENTI MIKUNI® 10/ 15/ 17,5/ 20/ 22,5/ 25

MIKUNI® SLOW JET

04 N° GICLEUR+SIZE	€ 7
--------------------	-----

**GICLEUR PRINCIPAL MIKUNI® 85/ 90/ 92,5/ 95/ 97,5/ 100/ 102,5/ 105/ 107,5/ 110/ 115/ 120**

MIKUNI® MAIN JET

05 N° GICLEUR+SIZE	€ 7
--------------------	-----

## POINTEAU CARBURATEUR

CARBURETOR FLOAT NEEDLE

06 N° FLON-50A (YCF50A)	
07 N° FLON-CARBU22 (MIKUNI® 22)	
08 N° 16008L (MIKUNI® 26)	€ 12

## AIGUILLE CARBURATEUR MIKUNI®

MIKUNI® CARBURETOR NEEDLE

09 N° 16004L	€ 15
--------------	------

## JOINT CUVE CARBURATEUR

CARBURETOR FLOAT BOWL GASKET

10 N° 16010L (MIKUNI® 26)	€ 5
11 N° SEAL-CARBU22 (MIKUNI® 22)	€ 5
12 N° SEAL-PE28 (KEIHIN® PE28)	€ 7
13 N° SEAL-50A (YCF 50A)	€ 5



**PIPE ADMISSION SANS BOÎTE À AIR**

INLET PIPE WITHOUT AIRBOX

01 N° 17311 € 16

**PIPE ADMISSION POUR BOÎTE À AIR 2025**

INLET PIPE FOR AIRBOX

02 N° 17311-2 (POUR/ FOR FACTORY SPII) € 19  
 02 N° 17311-4 (POUR/ FOR PILOT 125) € 19  
 02 N° 17311-5 (POUR/ FOR PILOT 150) € 19  
 02 N° 17311-6 (POUR/ FOR PE28) € 19  
 02 N° 17311-6-01 (POUR BOÎTE À AIR/ FOR AIRBOX 2025) € 19  
 02 N° 17311-3 (POUR/ FOR FACTORY SPIII) € 19

**JOINT PAPIER PIPE ADMISSION**

INLET PIPE PAPER GASKET

03 N° 17332/152FMH01 (ENTRE LA PIPE D'ADMISSION ET LE CARBURATEUR/ BETWEEN INLET PIPE AND CARBURATOR) € 2,50  
 03 N° 17332 (ENTRE LA CULASSE ET LA PIPE D'ADMISSION/ BETWEEN CYLINDER HEAD AND INLET PIPE) € 2,50

**CALE PLASTIQUE PIPE ADMISSION**

INLET PIPE PLASTIC HOLDER

04 N° 17331/152FMH € 6



FOR 50 ONLY



**STARTER AU GUIDON POUR YCF50A**

CHOKE LEVER FOR YCF50A

01 N° YC50-0142-01

€ 19



**CAGE DE FILTRE À AIR**

AIR FILTER CAGE

01 N° YC110-08-012

€ 10

02 N° YC110-08-013

€ 10

**MANCHON DE BOÎTE À AIR YCF**

YCF AIRBOX SLEEVE

03 N° YC110-08-0171 (Ø 49 POUR/ FOR KEIHIN® PE28)  
 03 N° YC110-08-017 (Ø 40)  
 03 N° YC110-08-0173 (PILOT 125 2015-2020)  
 03 N° YC110-08-0174 (PILOT 150 2016-2020/ SM150 2016-2020)  
 03 N° YC110-0823-02 (BIGY 125 2021-25)  
 03 N° YC110-0823-03 (SP3 2021-22 / BIGY 150 - 190 2021-25)  
 03 N° YC110-0823-04 (PILOT 125 2021-25)  
 03 N° YC110-0823-07 (PILOT 150 2021-25)

€ 10



**MANCHON SOUPLE**

FLEXIBLE SLEEVE

01 N° 17315 (VM 24)

€ 29

02 N° 46758 (POUR/ FOR DAYTONA®)

€ 35



**SURFILTRE À AIR (VENDU SANS FILTRE À AIR)**

AIR FILTER PROTECTION (AIR FILTER NOT INCLUDED)

N° K130K (POUR FILTRE ORIGINE YCF/ FOR YCF ORIGINAL AIR FILTER)  
 N° K386K (POUR/ FOR TWIN AIR)

€ 19



# FILTRES À AIR AIR FILTERS



**NOUVELLE BOÎTE À AIR**  
NEW AIRBOX

N° YC110-0801-12-01 (POUR/ FOR PILOT/ FACTORY/ BIGY/ GP/ SM 2026) € 59



**KIT POUR BOÎTE À AIR**  
AIR FILTER CAGE

N° YC110-0841-01 € 25



**FILTRE À AIR MOUSSE**  
FOAM AIR FILTER

01 N° TA-158430 (POUR/FOR AIR BOX PILOT/ FACTORY/ BIGY) € 22  
02 N° TA-158432 (Ø 40mm POUR/ FOR MIKUNI® 26mm) € 27  
03 N° TA-158431 (Ø 50mm POUR/ FOR KEIHIN® 28mm) € 27



**! PIPE ADMISSION ADÉQUATE, VOIR PAGE 132**  
SUITABLE INLET PIPE, CHECK PAGE 132

**NOUVELLE BOÎTE À AIR**  
NEW AIRBOX

01 N° YC110-0801-07 (POUR/ FOR PILOT 125 & 150, 2015-26) € 49  
02 N° YC110-08-02 (POUR/ FOR FACTORY 2012-26)  
03 N° YC110-0801-09 (POUR/ FOR LITE/ START)



**FILTRE À AIR MOUSSE**  
FOAM AIR FILTER

01 N° YC110-0802-03 (POUR/ FOR CARBU 22 mm)  
(POUR FOR LITE/ START 88/ GP107) € 22  
02 N° YC110-0802-10 (POUR/ FOR CARBU 26 MIKUNI/  
NIBBI PE19FL/ PE24SP)(POUR FOR LITE/ START 125/  
SM 125/150) € 22  
03 N° YC110-0802-05 (POUR/ FOR CARBU KEIHIN/  
NIBBI PE 28 mm) € 22



**FILTRE À AIR EN MOUSSE POUR BOÎTE À AIR**  
FOAM AIR FILTER FOR AIR BOX

N° YC110-0817-03-BL (PILOT 2016-22/ FACTORY 2012-26/ BIGY) € 17



**FILTRE À AIR EN MOUSSE POUR BOÎTE À AIR**  
FOAM AIR FILTER FOR AIR BOX

01 N° YC50-0802 (POUR/ FOR YCF 50) € 7  
02 N° YC110-0817-02 (POUR/ FOR LITE/ START) € 13  
03 N° YC110-0817-08 (POUR BOÎTE À AIR/ FOR AIRBOX 2026) € 13

# ÉCHAPPEMENTS EXHAUSTS



**SPECIAL PARTS  
YCF RACING**

**LAINES DE ROCHE POUR SILENCIEUX**  
MUFFLER PACKING FOR NOISE REDUCTION

**01** N° LR1 € 12

**BRIDE DE POT POUR SILENCIEUX**  
MUFFLER SPARK ARRESTOR

**02** N° YC110-13-30 € 30

**JOINT DE POT**  
EXHAUST SEAL

**03** N° 18291/152FMH € 2

**EMBOUT DE POT LITE/ START/ PILOT/ SM 2011-2026**  
EXHAUST END FOR LITE/ START/ PILOT/ SM 2011-2026

**04** N° YC110-13-32 € 19  
**08** N° YC110-13-35 (FACTORY) € 19

**RESSORT DE POT AVEC CAOUTCHOUC**  
EXHAUST SPRING WITH RUBBER

**05** N° YC110-13-21 € 5

**EMBOUT SILENCIEUX POUR LAVAGE MOTO**  
WASH MUFFLER PLUG

**06** N° EEP-BL € 5

**BRIDE DE POT**  
SPARK ARRESTOR

**07** N° BP30BLACK (Ø 30) € 19

**DB KILLER FACTORY**  
DB KILLER FACTORY

**09** N° YC110-1317-02 € 19



**ATTACHE SILENCIEUX OVALE (88, RS, RSP, SM 2011-26)**  
OVAL MUFFLER CLAMP (88, RS, RSP, SM 2011-26)

N° YC110-13-06

€ 15



# ÉCHAPPEMENTS RACING RACING EXHAUSTS



**FACTORY**  
SPECIAL PARTS  
YCF RACING

**LIGNE ÉCHAPPEMENT COMPLÈTE RACING SIMPLE**  
COMPLETE RACING EXHAUST SINGLE

N° YC110-136-07-BK (POUR/ FOR PILOT/ SM150)  
N° YC110-139-07-BK (POUR/ FOR FACTORY)  
N° YC110-140-01-BK (POUR/ FOR BIGY)

€ 299



**FACTORY**  
SPECIAL PARTS  
YCF RACING

**ATTACHE SILENCIEUX FACTORY**  
FACTORY MUFFLER CLAMP

N° YC110-1307-03

€ 19



**RESSORT DE POT FACTORY**  
FACTORY EXHAUST SPRING WITH RUBBER

N° YC110-1310-01

€ 3



**FACTORY**  
SPECIAL PARTS  
YCF RACING

**SILENCIEUX RACING FACTORY**  
FACTORY RACING EXHAUST

N° YC110-13014-03BK

€ 149



**SILENCIEUX ANTI-BRUIT**  
SPARK ARRESTOR

N° YC110-13014-02-GY

€ 159



**FACTORY**  
SPECIAL PARTS  
YCF RACING

**LIGNE ÉCHAPPEMENT COMPLÈTE RACING DOUBLE**  
COMPLETE RACING EXHAUST TWIN

N° YC110-136-08-BK (POUR/ FOR PILOT/ SM150)  
N° YC110-139-08-BK (POUR/ FOR FACTORY)  
N° YC110-140-02-BK (POUR/ FOR BIGY)

€ 399



**COLLECTEUR RACING**  
RACING MID PIPE

N° YC110-1302-22 (PILOT) € 89  
 N° YC110-1302-13 (SP3) € 89  
 N° YC110-1308-01 (BIGY) € 89



**Y DU COLLECTEUR RACING DOUBLE**  
DOUBLE RACING MID PIPE Y

N° YC110-1302-23 (PILOT)  
 N° YC110-1302-14 (SP)  
 N° YC110-1308-03 (BIGY) € 79



**PARTIE INTERMÉDIAIRE COLLECTEUR RACING**  
RACING MID PIPE INTERMEDIATE PART

N° YC110-1302-24 (PILOT)  
 N° YC110-1302-15 (SP)  
 N° YC110-1308-02 (BIGY) € 49



**ÉCHAPPEMENT YCF ANTI-BRUIT (GAMME FACTORY)**  
SPARK ARRESTOR YCF EXHAUST (FACTORY RANGE)

N° YC110-139-03 (POUR/ FOR FACTORY SP2 & SP3)  
 N° YC110-139-09 (POUR/ FOR BIGY) € 249



**COLLECTEUR ÉCHAPPEMENT FACTORY**  
FACTORY EXHAUST MID PIPE

N° YC110-13028-01 (SP3) € 119  
 N° YC110-13028-03 (BIGY 190) € 119  
 N° YC110-13028-05 (PILOT) € 119  
 N° YC110-13028-02 (SP3 DOUBLE) € 149  
 N° YC110-13028-04 (BIGY DOUBLE) € 149  
 N° YC110-13028-06 (PILOT DOUBLE) € 149



**ÉCHAPPEMENT GROS DIAMÈTRE AVEC BRIDE DE POT AMOVIBLE**  
LARGE DIAMETER EXHAUST SUPPLIED WITH REMOVABLE SPARK ARRESTOR

N° YC110-136-GY (POUR/ FOR LITE/ START) € 99  
 N° YC110-136-03-GY (POUR/ FOR PILOT/ SM 150) € 99  
 N° YC110-139-10 (POUR/ FOR BIGY) € 169



**COLLECTEUR ÉCHAPPEMENT BIGY**  
BIGY EXHAUST MID PIPE

N° YC110-1302-20 (125/150 BIGY MX) € 59  
 N° YC110-1302-28 (150 BIGY FACTORY) € 69

# FILTRES & RADIATEURS FILTERS & COOLERS

**NEW  
2026**



**KIT COMPLET RADIATEUR HUILE**  
COMPLETE OIL COOLER KIT

N° YC110-2306-02

€ 95



**KIT RADIATEUR UNIVERSEL ADAPTABLE SUR TOUS LES MODÈLES**  
UNIVERSAL OIL COOLER KIT ADAPTABLE TO ALL MODELS

N° YC110-2306 (VENDU AVEC 6 DURITES/ SOLD WITH 6 HOSES)

€ 199



**PETITE JAUGE HUILE NOIRE/ BLEUE/ ROUGE/ VERTE/ ORANGE**  
LITTLE OIL DIPSTICK BLACK/ BLUE/ RED/ GREEN/ ORANGE

01 N° JH01-COLOR (SM150/ FACTORY/ BIGY FACTORY 150/190) € 19



**FILTRE À HUILE**  
OIL FILTER

01 N° 216E010 € 19  
02 N° 14210-1038-0000 (110/125/155 ZONGSHEN FIDDY RACER) € 9  
LITE110R/ SM125/155/ PILOT 125 2022/ BIGY 125 2022-26

**ÉPURATEUR D'HUILE ALLÉGÉ**  
FLYWHEEL

03 N° 208G082 € 25



**DURITE HUILE RADIATEUR**  
OIL COOLER HOSE

N° YC110-23-01 (2007)  
N° YC110-23-013 (L=400MM)  
N° YC110-23-014 (L=285MM/ Ø=10)  
N° YC110-23-015 (L=260MM/ Ø=8/8)  
N° YC110-23-016 (L=125MM/ Ø=10/8)  
N° YC110-23-017 (L=290MM/ Ø=10/10)  
N° YC110-23-0003 (L=110MM/ Ø=10/8)  
N° YC110-23-02 (2007)  
N° YC110-23-022 (L=490MM)  
N° YC110-23-023 (L=395MM/ Ø=10/8)  
N° YC110-23-024 (L=495MM/ Ø=10/8 )  
N° YC110-23-025 (L=360MM/ Ø=10/10)

€ 19

**SPECIAL PARTS  
YCF RACING**



**JAUGE HUILE NOIRE/ BLEUE/ ROUGE/ VERTE/ ORANGE/ VIOLET**  
OIL DIPSTICK BLACK/ BLUE/ RED/ GREEN/ ORANGE/ PURPLE

N° JH-COLOR (LITE/ START/ PILOT/ BIGY 125/150 MX)

€ 19

**SPECIAL PARTS  
YCF RACING**



**BOUCHON VIDANGE AIMANTÉ**  
NOIR/ BLEU/ ROUGE/ VERT/ ORANGE/ VIOLET  
MAGNETIC DRAIN PLUG  
BLACK/ BLUE/ RED/ GREEN/ ORANGE/ PURPLE

01 N° BVE1-COLOR

€ 12

**HUBLOT À HUILE**  
OIL LEVEL SIGHT GLASS

02 N° D00C027

€ 10

# ALLUMAGE IGNITION



## FAISCEAU ÉLECTRIQUE WIRING HARNESS

- 01 N° YC110-1501 (NON ÉTANCHE/ NO WATERPROOF) € 15
- N° YC110-1501-12 START SE 88/125 (CONNECTEUR ÉTANCHE/ WATERPROOF CONNECTION) € 15
- N° YC110-1501-08 BIGY (DÉMARREUR ÉLECTRIQUE/ ÉLECTRIC START/ CONNECTEUR ÉTANCHE/ WATER-PROOF CONNECTION) € 19
- N° YC110-1501-09 BIGY (SANS DÉMARREUR/ WITHOUT ÉLECTRIC START CONNECTEUR ÉTANCHE/ WATERPROOF CONNECTION) € 19
- N° YC110-1501-11 (LITE/START/PILOT/SP) (SANS DÉMARREUR/ WITHOUT ÉLECTRIC START CONNECTEUR ÉTANCHE/ WATERPROOF CONNECTION) € 19

## BOÎTIER CDI CDI BOX

- 02 N° YC110-1503 € 15

## BOBINE HAUTE TENSION HIGH TENSION IGNITION COIL

- 03 N° YC110-1504 € 15

## BATTERIE BATTERY

- 04 N° YC110-1507-02 (50A/ 88/ 125/ 150) € 39
- 04 N° YC110-1507-04 (BIGY) € 45



## CDI RACING CDI RACING

- N° YC110-1503-01 € 29



## ALLUMAGE YCF YCF IGNITION

- 01 N° YC50-1502 (RÉGULATEUR DE TENSION/ TENSION REGULATOR) € 15
- 02 N° YC50-1510 (RELAIS DÉMARREUR/ STARTER RELAY) € 15
- 03 N° YC50-1507-01 (BATTERIE POUR 50A/ BATTERY FOR 50A AVANT/ BEFORE 2019) € 35
- 04 N° YC50-1514 (CHARGEUR BATTERIE/ BATTERY CHARGER) € 35
- 05 N° YC110-1564 (CONTACTEUR À CLÉ AVEC LE SUPPORT/ WATERPROOF KEY SWITCH) € 15
- 06 N° 82200-D083-000151 (DÉMARREUR 88/ 125SE) € 59
- 07 N° YC50-20-66 (DÉMARREUR 50A) € 59
- 08 N° YC110-1563-01 (SHUNT ÉTANCHE/ SHUNT WATERPROOF) € 3
- 09 N° YC110-2025-ZC SUPPORT DÉMARREUR ÉLECTRIQUE SE MONTE SUR START 88SE/ START 125SE/ PILOT 150E/ BIGY 150E FACTORY € 10



## ALLUMAGE MAGNETO

- 01 N° RRG-04 (ÉTANCHE-WATERPROOF) € 99
- 02 N° 31100/152FMH € 69
- 03 N° 31210/152FMH-WP (PRISE ÉTANCHE) € 39
- 04 N° 82120-G011-30534 (START SE) € 35





**COUPE CIRCUIT**  
REMOTE SWITCH

- 01 N° YC110-0105-01 (SWITCH ON/OFF) € 15
- 02 N° YC110-0105 (SWITCH) € 20
- 03 N° YC110-0105-21(SWITCH-WATERPROOF) € 15
- 07 N° YC110-0139-03 (BOUTON DÉMARREUR/ START SWITCH) € 29
- 08 N° YC110-0105-07 (POUR MOTEURS DAYTONA/ FOR DAYTONA ENGINES) € 29
- 09 N° YC110-0105-08 (TOUS LES MODÈLES SAUF AVEC MOTEURS DAYTONA/ ALL MODELS EXCEPT DAYTONA ENGINES) € 29

**COMPTEUR D'HEURE & SUPPORT**  
HOUR METER & SUPPORTING PLATE

- 04 N° STANDCOMPT-H (SUPPORT/SUPPORTING PLATE) € 10
- 10 N° COMPT-H (COMPTEUR D'HEURE/ HOUR METER) € 29
- 05 N° COMPT01-H (COMPTEUR D'HEURE VIBRATION/ HOUR METER) € 39
- 06 N° COMPT02-H (COMPTEUR D'HEURE ET COMPTE TOURS/ HOUR METER AND TACHOMETER) € 45



FOR 50 ONLY

**COUPE CIRCUIT À DISTANCE**  
VENDU AVEC 2 TÉLÉCOMMANDES

DISTANCE ENGINE CUT OFF  
SOLD WITH 2 REMOTES CONTROL

N° YC50-1518 € 59



**BOUGIE & ANTI PARASITE**

SPARK PLUG & SPARK PLUG CAP

- 01 N° 221D021 SP3/ BIGY 190/ BIGY 190 XL/ SUNDAY 187/ GP 187 (4 SOUPAPES YX/ YX 4 STROKE) € 39
- 02 N° 34210/152FMH YCF 50A/ START 125/ PILOT/ SP2 / BIGY MX/ BIGY 150 FACTORY/ GP 124/ GP 157 (CR7HS) € 9
- 03 N° 34210/D8EA LITE/ START 88SE/ START 125SE € 9
- 04 N° YC110-1505 (CAP/ ANTI PARASITE) € 7



**NEW  
2026**



**HUILE YCF  
YCF LUB**



**HUILE MOTEUR 10W-40 CAPACITÉ 1L**  
ENGINE OIL 10W-40 CAPACITY 1L

N° LUB-10W40

€ 14,90



**HUILE DE FOURCHE 10W CAPACITÉ 1L**  
FORK OIL 10W CAPACITY 1L

N° LUB-FORK-10W

€ 16,90



**HUILE DE FOURCHE 15W CAPACITÉ 1L**  
FORK OIL 15W CAPACITY 1L

N° LUB-FORK-15W

€ 16,90



**HUILE DE FOURCHE 20W CAPACITÉ 1L**  
FORK OIL 20W CAPACITY 1L

N° LUB-FORK-20W

€ 16,90



**HUILE DE FREIN DOT4 CAPACITÉ 0,25L**  
BRAKE FLUID DOT4 CAPACITY 0.25L

N° LUB-DOT4

€ 5,90



**HUILE DE CHAÎNE CAPACITÉ 0.45L**  
CHAIN OIL CAPACITY 0.5L

N° LUB-CHAINLUBE

€ 13,90



**PULVÉRISATEUR FILTRE À AIR CAPACITÉ 0,45L**  
AIR FILTER SPRAY CAPACITY 0.45L

N° LUBE-AIRFILTERSPRAY

€ 14,90



**PRÉSENTOIR D'HUILE**  
OIL RACK

N° OIL-RACK

€ 249

# DAYTONA® ANIMA® RACING PARTS/PIECES RACING



**CHAÎNE DE DISTRIBUTION RENFORCÉE D.I.D**  
D.I.D REINFORCED TIMING CHAIN

N° 87577

€ 69



**PISTON FORGÉ POUR ANIMA®**  
FORGED PISTON FOR ANIMA®

N° 87173 (150cc)  
N° 88599 (190cc)

€ 99  
€ 109



**KIT ARBRE À CAME RACING**  
RACING CAMSHAFT KIT

N° 87583

€ 299



**KIT 212cc**  
212cc KIT

N° 88011

€ 379



**KIT ALLUMAGE F-SM RÉGLABLE**  
MULTI CURVES ROTOR KIT

N° 87235

€ 269



**COUVRE FILTRE HUILE ANIMA® NOIR/ BLEU/ ROUGE/  
VERT/ ORANGE/ VIOLET**

ANIMA® OIL FILTER COVER BLACK/ BLUE/ RED/ GREEN/  
ORANGE/ PURPLE

N° OFCDAYT-COLOR

€ 25



**COUVRE CULASSE ANIMA® RACING**  
ANIMA® RACING CYLINDER HEAD COVER

N° 87994

€ 49



**PIPE ADMISSION ANIMA® 15°**  
INTAKE MANIFOLD ANIMA® 15°

N° YC110-2012-01

€ 45



**CHAÎNE DE DÉMARREUR RENFORCÉE DID**  
STARTER CHAIN DID

N° 89522

€ 49

# DAYTONA®

# DAYTONA® ANIMA® 2,0 150/ 190cc (4 VALVES) GENUINE PARTS/ PIÈCES D'ORIGINES

**DAYTONA**

SEQ #	PART #	DESCRIPTION	QTY	(€) UNIT PRICE
1	86461	BOLT, CROSS RECESSED COUNTERSUNK M6x15	2	1,00
2	86464	BOLT, HEXAGON FLANGE M6x25	2	1,00
3	86472	BOLT, HEXAGON FLNAGE M6x32	1	1,00
4	87349	BOX, CDI, DESIGNATION FDX	1	119,00
4	89373	BOX, CDI FSM-SYS 2024	1	99,00
5	86426	COIL, IGNITION	1	19,00
6	86373	COVER, MAGNET	1	39,00
7	89678	FLYWHEEL MAGNET COMP FDX	1	69,00
7	88127	FLYWHEEL MAGNET COMP FSM-SYS 2024	1	65,00
8	86452	NUT, MAGNET M12	1	2,00
9	86479	O-RING, Ø6,5xØ1,8	2	2,00
10	86916	STATOR ASSY, DESIGNATION FDX	1	69,00
10	88129	STATOR ASSEMBLY FSM	1	65,00
10	80744	STATOR ASSY, SYS 2024	1	65,00
11	86428	WIRE HERNESS	1	39,00

**DAYTONA**

SEQ #	PART #	DESCRIPTION	QTY	(€) UNIT PRICE
1	84678	BOLT, CROSS RECESSED COUNTERSUNK M6x30	1	2,00
2	84677	BOLT, CROSS RECESSED COUNTERSUNK M6x35	2	2,00
3	84676	GASKET, PUMP OIL	1	2,00
4	83747	PIN, DOWEL Ø8xØ6,3x12	2	2,00
5	86382	PUMP, OIL ASSY	1	49,00

**DAYTONA**

SEQ #	PART #	DESCRIPTION	QTY	(€) UNIT PRICE
1	86446	BOLT, BANJO M10x22,5	2	3,00
2	86362	BOLT, HEXAGON FLANGE M6x105	1	2,00
3	86486	BOLT, HEXAGON FLANGE M6x15	2	3,00
4	86469	BOLT, HEXAGON FLANGE M6x22	2	2,00
5	86485	BOLT, HEXAGON FLANGE M6x28	2	2,00
6	86471	BOLT, HEXAGON FLANGE M6x30	2	2,00
7	86473	BOLT, HEXAGON FLANGE M6x50	2	2,00
8	86474	BOLT, HEXAGON FLANGE M6x55	1	2,00
9	83759	BOLT, HEXAGON FLANGE M6x60	1	2,00
10	86361	BOLT, HEXAGON FLANGE M6x90	1	2,00
11	86376	COVER, CLUTCH	1	119,00
12	86374	COVER, OIL FILTER	1	15,00
13	86377	COVER, SMALL CLUTCH	1	59,00
14	86384	FILTER, OIL	1	19,00
15	86437	GASKET, COVER CLUTCH	1	15,00
16	86476	GASKET, M10	4	2,00
17	86412	HOLDER, CABLE CLUTCH	1	9,00
18	86414	LEVER, CLUTCH COMP	1	35,00
19	86432	O-RING, Ø38,6x2,6	1	3,00
20	86435	O-RING, COVER SMALL CLUTCH	1	5,00
21	86441	OIL SEAL, Ø16xØ26x7	1	5,00
22	86442	OIL SEAL, Ø17xØ10x5	1	4,00
23	86406	OIL THROUGH COMP	2	25,00
24	83747	PIN, DOWEL Ø8xØ6,3x12	4	2,00
25	86386	RULER	1	5,00
26	86413	SPRING, LEVER CLUTCH	1	2,00
27	86375	SPRING, OIL FILTER	1	2,00
28	86475	WINDOW, OIL LEVEL	1	15,00

**DAYTONA**

## ALLUMAGE GENERATOR ANIMA® 2,0 150/ 190CC

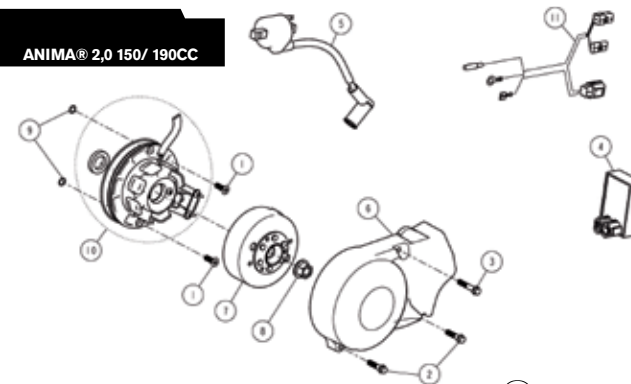

**DAYTONA**

## POMPE À HUILE OIL PUMP ANIMA® 2,0 150/ 190CC

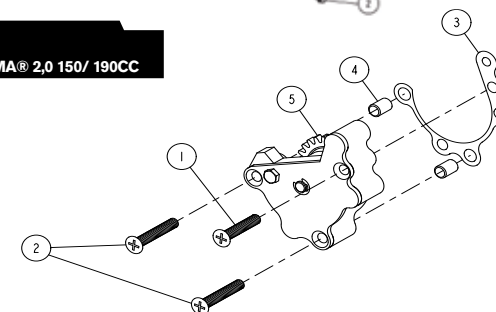

**DAYTONA**

## CARTER EMBRAYAGE COVER CLUTCH ANIMA® 2,0 150/ 190CC

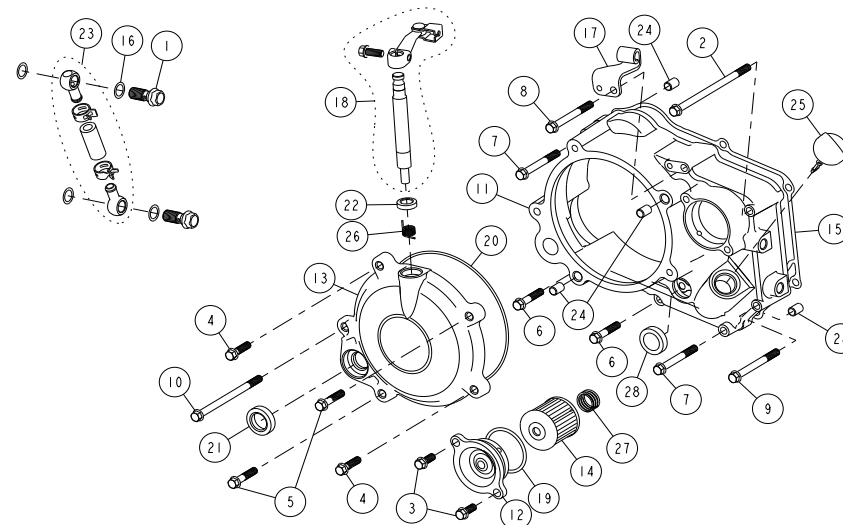

DAYTONA

SEQ #	PART #	DESCRIPTION	QTY	(€) UNIT PRICE
1	86453	CLIP, PIN PISTON	2	2,00
2	86381	CRANK SHAFT ASSY ANIMA 150	1	199,00
3	86620	CRANK SHAFT ASSY ANIMA 190	1	219,00
3	87760	CRANK SHAFT ASSY ANIMA 160	1	199,00
3	89144	CRANK SHAFT ASSY ANIMA 190-5 SPEEDS	1	229,00
3	80601	CRANK SHAFT ASSY ANIMA 190 SYS 2024	1	229,00
4	86383	GEAR, OIL PUMP DRIVE	1	15,00
5	86415	GEAR, PRIMARY DRIVE	1	29,00
6	83768	NUT, SMALL M14	1	5,00
7	86443	OIL SEAL, Ø12xØ20x5t	1	6,00
8	86379	PIN, PISTON Ø14	1	5,00
8	89978	PIN PISTON L=39 SYS 2024	1	5,00
9	86378	PISTON DT150	1	59,00
10	86621	PISTON DT190	1	65,00
10	80316	PISTON 190 SYS 2024	1	69,00
11	86462	RETAINING RING, RTWN22	1	2,00
12	86380	RING SET, PISTON	1	30,00
12	89977	RING SET, PISTON 66MM-SYS 2024	1	30,00
13	86411	WASHER, SPRING	1	3,00

DAYTONA

PISTON & VILEBREQUIN  
PISTON & CRANK SHAFT

ANIMA® 2,0 150/ 190CC

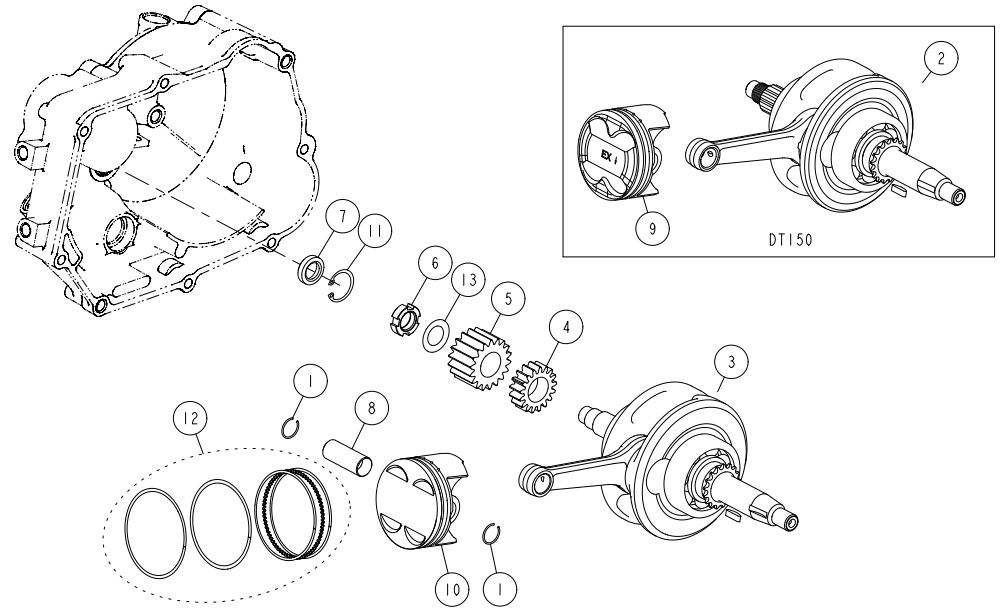

DAYTONA

SEQ #	PART #	DESCRIPTION	QTY	(€) UNIT PRICE
1	86474	BOLT, HEXAGON FLANGE M6x55	1	2,00
2	83761	BOLT, HEXAGON FLANGE M6x65	1	2,00
3	86360	BOLT, HEXAGON FLANGE M6x70	5	2,00
4	86459	BOLT, HEXAGON SOCKET M6x105	2	3,00
5	83755	BOLT, OIL DRAIN M12x15	1	3,00
6	86444	BOLT, STUD A	2	6,00
7	86445	BOLT, STUD B	2	6,00
8	86369	COVER, STRAINER OIL	1	5,00
9	86370	CRANK CASE, LH	1	129,00
9	89143	CRANK CASE, LH, 5 SPEEDS	1	149,00
10	86884	CRANK CASE, RH	1	119,00
10	88848	CRANK CASE, RH, 5 SPEEDS	1	119,00
11	86438	GASKET, CRANKCASE	1	9,00
12	86371	HOSE, BREATHER	1	12,00
13	86451	NUT FLANGE, M8	4	2,00
14	86433	O-RING, Ø30xØ3	1	2,00
15	83720	PIN, DOWELØ10xØ8,4x14	2	2,00
16	86385	SPRING, STRAINER	1	2,00
17	86387	STRAINER, OIL	1	5,00
18	86457	WASHER, GASKET M8	4	2,00
19	83754	WASHER, OIL DRAIN M12	1	5,00

DAYTONA

CARTER  
CRANKCASE

ANIMA® 2,0 150/ 190CC

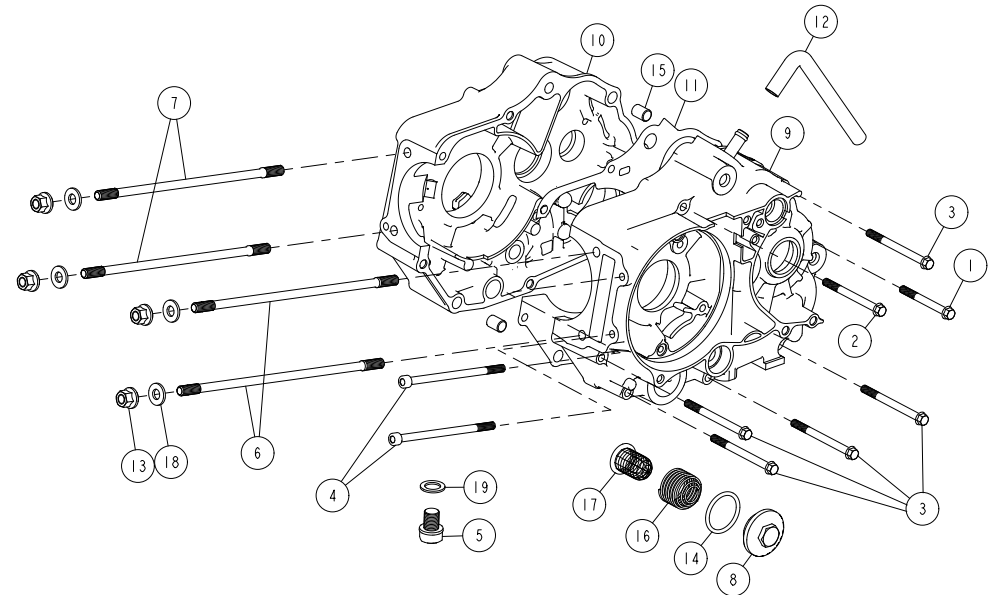

SEQ #	PART #	DESCRIPTION	QTY	(€) UNIT PRICE
1	86448	BOLT, HEXAGON FLANGE M10x16	1	3,00
2	85877	BOLT, HEXAGON FLANGE M6x12	1	1,00
3	86468	BOLT, HEXAGON FLANGE M6x18	6	1,00
4	86466	BOLT, HEXAGON FLANGE M6x25	1	1,00
5	86471	BOLT, HEXAGON FLANGE M6x30	1	2,00
6	83703	BOLT, STUD M6x32	2	2,00
7	86367	COVER, CYLINDER HEAD	1	45,00
8	86366	CYLINDER	1	249,00
8	87975	CYLINDER 190 SYS 2024	1	339,00
9	89458	GASKET,BASE CYLINDER 190 SYS 2024	1	19,00
9	86436	GASKET, BASE CYLINDER	1	15,00
10	86440	GASKET, HEAD CYLINDER	1	19,00
11	86476	GASKET, M10	1	2,00
12	86405	GASKET, MANIFOLD	1	2,00
13	86439	GASKET, TANSIONER CAM CHAIN	1	2,00
14	86368	HEAD, CYLINDER	1	249,00
15	86404	MANIFOLD, INTAKE	1	25,00
16	86479	O-RING	1	2,00
17	86434	O-RING, COVER HEAD	1	15,00
18	83720	PIN, DOWEL Ø10xØ8,4x14	4	2,00
19	83747	PIN, DOWEL Ø8xØ6,3x12	1	2,00
20	221D021	SPARK PLUG ER9EH	1	45,00
21	86396	TENSIONER, CAM CHAIN COMP	1	25,00
22	86456	WASHER, Ø6,3xØ12x1,5	1	2,00

CULASSE ANIMA®  
HEAD CYLINDER

ANIMA® 2,0 150/ 190CC

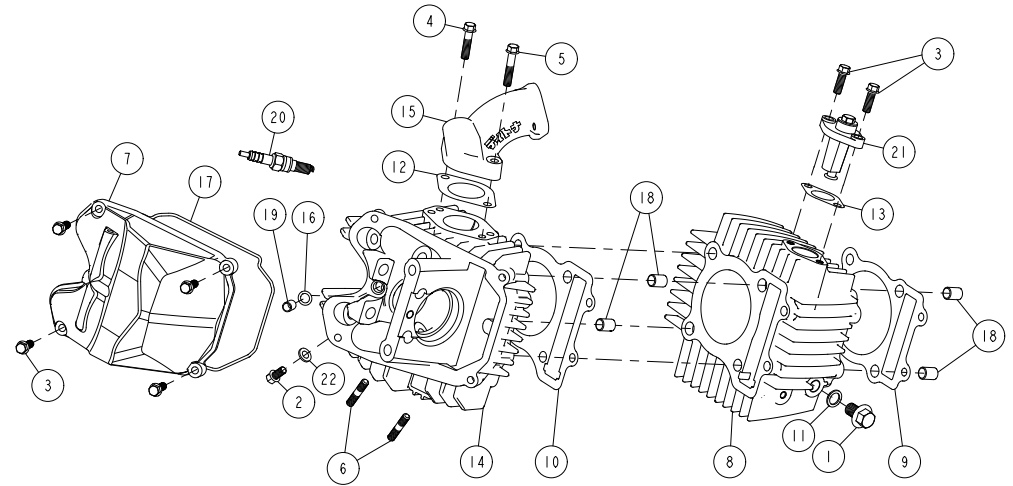

SEQ #	PART #	DESCRIPTION	QTY	(€) UNIT PRICE
1	86481	ARM, ROCKER ROLLER EXHAUST COMP	1	59,00
2	86393	ARM, ROCKER ROLLER INTAKE COMP	1	59,00
3	86460	BOLT, COUNTERSINK M6x15	1	1,00
4	86883	SCREW M6X16	2	2,00
5	86447	BOLT, TENSIONER	1	3,00
6	86878	CAMSHAFT 240Ø ROLLER DECOMP ASM	1	99,00
7	86391	CHAIN, CAMSHAFT DRIVE	1	35,00
8	86402	COTTER, VALVE	8	5,00
9	89681	SHAFT W/WEIGHT,DECOMP,V3	1	49,00
10	86395	GUDE , CHAIN CAMSHAFT	1	20,00
11	86389	PLATE, STOPPER CAM	1	5,00
12	86400	RETAINER, SPRING VALVE	4	5,00
13	86403	SEAL, VALVE STEM Ø4.5	4	6,00
14	86401	SEAT, SPRING VALVE	4	4,00
15	86392	SHAFT, ROCKER	2	5,00
16	87621	SPRING,RETURN DECOMP.	1	3,00
17	86624	SPRING, VALVE	4	16,00
18	86879	SPROCKET, CAMSHAFT DRIVEN	1	19,00
19	87620	PLATE,STOPPER DECOMP.	1	4,00
20	86394	TENSIONER, CAM CHAIN	1	20,00
21	86623	VALVE, EXHAUST Ø21	2	30,00
22	86397	VALVE, INTAKE Ø24.5	2	19,00

DISTRIBUTION  
VALVE MECHANIS

ANIMA® 2,0 150/ 190CC

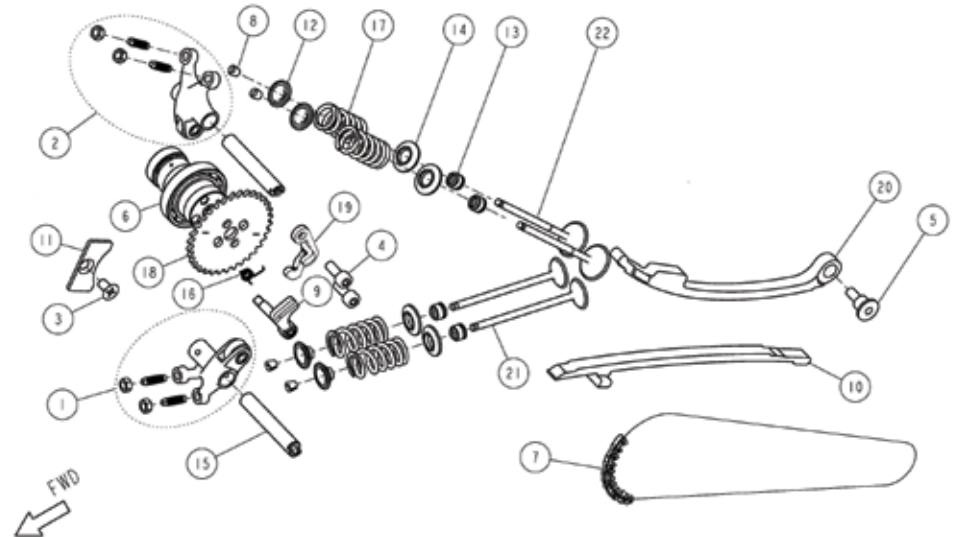

**DAYTONA**

SEQ #	PART #	DESCRIPTION	QTY	(€) UNIT PRICE
1	83786	BEARING, #6000	1	7,00
2	87619	CLUTCH COMP (FORGED GEAR)	1	199,00
3	86417	GEAR, STARTER DRIVEN 2 13T	1	25,00
4	83768	NUT, SMALL M14	1	5,00
5	83787	PIN, LIFTER CLUTCH	1	20,00
6	86410	WASHER, SPRING Ø24xØ14,2x1,2 1	1	1,00

**DAYTONA**

**EMBRAYAGE  
CLUTCH**

ANIMA® 2,0 150/ 190CC

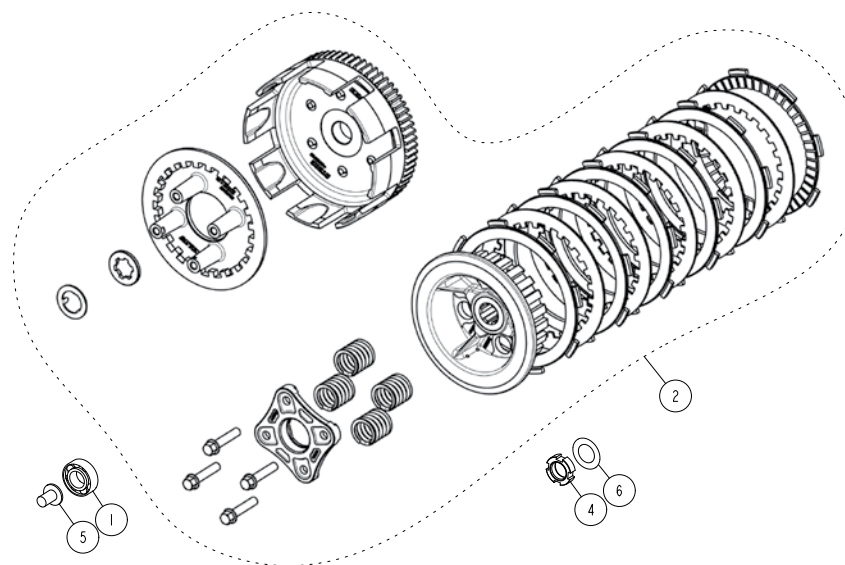

**DAYTONA**

SEQ #	PART #	DESCRIPTION	QTY	(€) UNIT PRICE
1	83788	BEARING #6001	1	12,00
2	83795	BEARING #6203	2	15,00
3	86454	BEARING NK152712	1	15,00
4	86464	BOLT, HEXAGON SOCKET M6x10	2	1,00
5	86418	GEAR IDLE, STARTER	1	20,00
6	86919	GEAR, COMP,4 SPEED	1	149,00
6	89682	GEAR, COMP 5 SPEED	1	149,00
7	83796	OIL SEAL, Ø29xØ17x5	1	3,00
8	86420	PLATE, FIXING SPROCKET DRIVE	1	2,00
9	86463	RETAINING RING Ø13,6	1	2,00
10	86419	SPROCKET, DRIVE 15T	1	15,00
11	86455	WASHER, Ø22xØ15x0,5	2	1,50

**DAYTONA**

**BOÎTE DE VITESSE  
GEARBOX**

ANIMA® 2,0 150/ 190CC

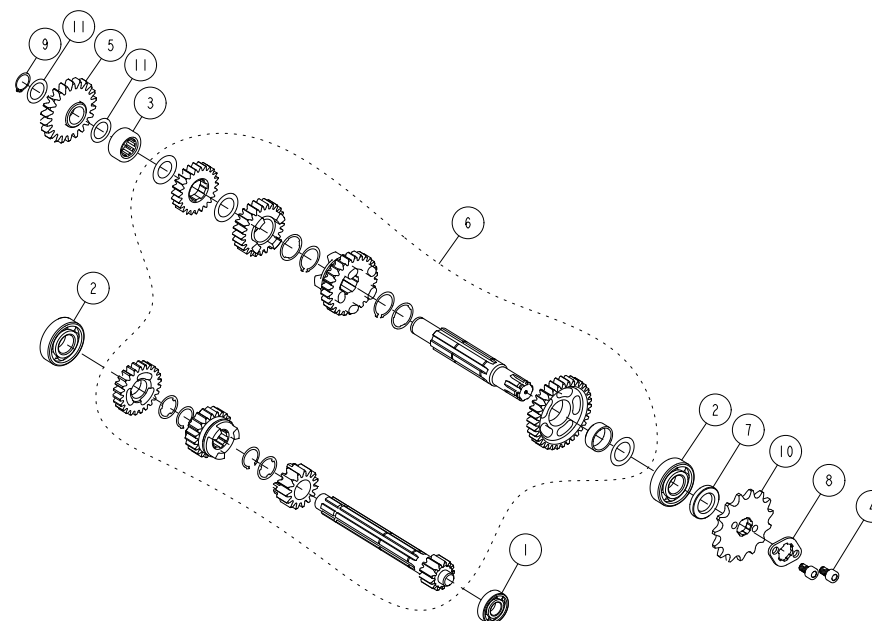



SEQ #	PART #	DESCRIPTION	QTY	(€) UNIT PRICE
1	86449	BOLT, HEXAGON SOCKET M6	1	2,00
2	85877	BOLT, HEXAGON SOCKET M6x15	1	1,00
3	83833	CONTACT, GEAR INDICATION	1	3,00
4	86421	DRUM, SHIFT N-1-2-3-4 COMP	1	55,00
4	88423	DRUM, SHIFT 5 SPEEDS	1	55,00
6	86422	LEVER, GEAR SHIFT COMP	1	20,00
6	88886	LEVER, GEAR SHIFT COMP 5 GEAR	1	20,00
7	86424	LOCATING PLATE UNIT	1	4,00
8	83837	OIL SEAL, Ø24xØ16x10	1	6,00
9	86480	PIN, LOCATING SHIFT LEVER	1	3,00
10	85876	PLATE, LOCATING SWITCH NEUTRAL	1	2,00
11	86423	SPRING, LOCATING PLATE	1	2,00



**BOÎTE/ FOURCHETTES  
GEARBOX MECHANISM**

ANIMA® 2,0 150/ 190CC

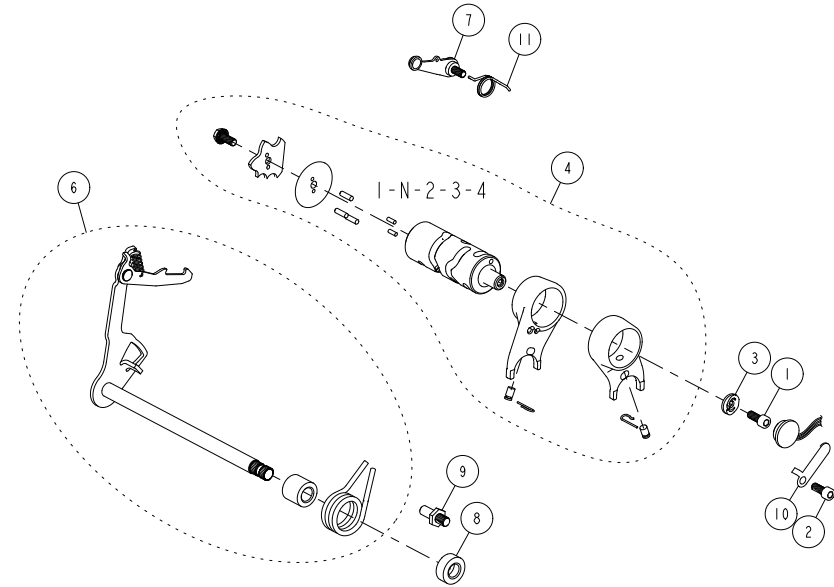

SEQ #	PART #	DESCRIPTION	QTY	(€) UNIT PRICE
1	86407	KICK STARTER ASM	1	75,00
1	88883	KICK ASSY 5 GEAR	1	69,00



**KICK  
KICK STARTER**

ANIMA® 2,0 150/ 190CC

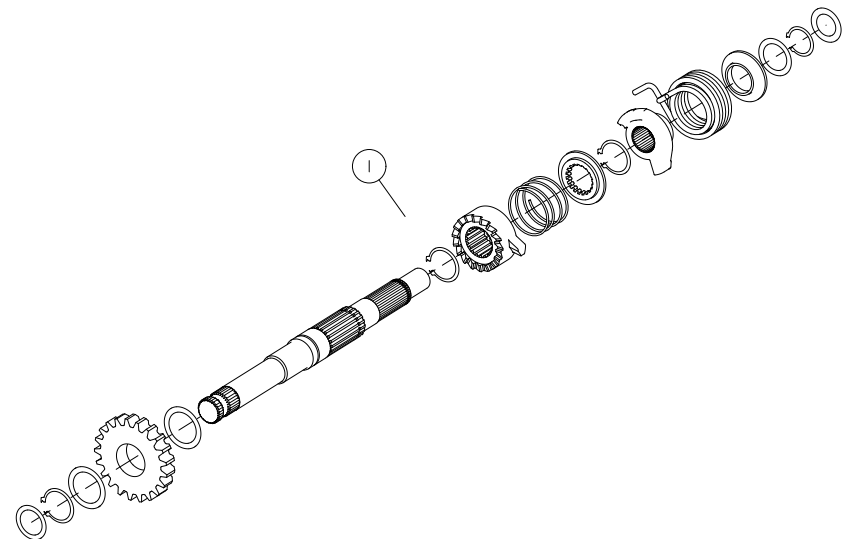



**ART DIRECTION**

ENCORE STUDIO

**GRAPHIC DESIGN**

F. ALAUX, T. JUMIN & Q. BRACHET

**INDUSTRIAL DESIGN**

FRANÇOIS ALAUX FOR YCF MOTORCYCLES

**THANKS TO**

#111

STEPHANE LE CORRE, CATHERINE HOSSARD & YCF CREW MEMBERS

CLÉMENT CALLEY/ MADY HUAN/ TIMÉO DUPLESSIS/ CLÉMENT DUPLESSIS

JUSTIN WALBE/ GEOFFROY DEHAYE

**TRACK**

CIRCUIT DE LESSAY

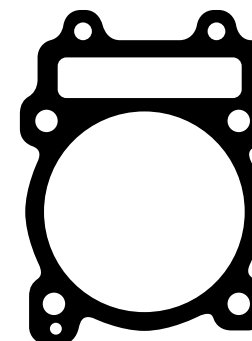

**PHOTOGRAPHY**

ACTION & STUDIO: JEAN-FRANÇOIS MUGUET, VALEX

PARTS: ANTOINE CADOT

**YCF FOUNDERS**

DIMITRI BERA & YANNICK COQUARD



[WELCOMETOENCORE.COM](http://WELCOMETOENCORE.COM)

# SUNDAY<sup>®</sup>



**RETROUVER NOTRE GAMME DE MOTOS SUNDAY  
SUR NOTRE SITE SUNDAY-MOTORS.COM**



**YEP**<sup>TM</sup>

ENJOY YOUR RIDE



**YEP RIDING.COM**